

Showerpipe with shower thermostat without hand shower - Brushed Dark Platinum

IMO









34 460 979



Fits: IMO, LULU, TARA, LISSÉ, VAIA, META

- shower with fixed riser projection 453mm
- overhead shower: rain flow
- rain shower Ø 300 mm
- rain shower with anti-scale system
- max. rainshower flow 14 l/min
- Function from: 10 l/min
- rotary diverter with volume control and shut-off function
- slide-on rosettes Ø 70 mm
- height of fittings up to rain shower (bottom edge) 1009mm
- height of fittings up to top edge of elbow 1150mm
- gauge 150 mm - 13 mm
- metal shower hose 1750mm with integrated anti-twist protection
- 1/2" connection
- slide bar
- Pipe diameter 23.5 mm
- quick clearing
- WRAS 2204013

This article does not include a hand shower!
Intrinsic protection against back flow.

	Brushed Dark Platinum	34 460 979-99
	Chrome	34 460 979-00
	Brushed Platinum	34 460 979-06
	Platinum	34 460 979-08
	Dark Chrome	34 460 979-19
	Dark Chrome	34 460 979-19 0010
	Light Gold	34 460 979-26
	Brushed Light Gold	34 460 979-27
	Brushed Durabronze (23kt Gold)	34 460 979-28
	Matte Black	34 460 979-33
	Brushed Bronze	34 460 979-42
	Brushed Champagne (22kt Gold)	34 460 979-46
	Champagne (22kt Gold)	34 460 979-47
	Brushed Chrome	34 460 979-93

Showerpipe with shower thermostat without hand shower - Brushed Dark Platinum

IMO

34 460 979

Required miscellaneous

	Hand shower - Brushed Dark Platinum	28 012 979-99
---	--	---------------

Required miscellaneous

	Hand shower - Brushed Dark Platinum	28 017 979-99
---	--	---------------

Required miscellaneous

	Hand shower - Brushed Dark Platinum	28 016 979-99
---	--	---------------

Required miscellaneous

	Hand shower FlowReduce - Brushed Dark Platinum	28 018 979-99 0010
---	---	-----------------------

Required miscellaneous

	SERIES-VARIOUS Hand shower - Brushed Dark Platinum	28 029 979-99
---	---	---------------

Required miscellaneous

	SERIES-VARIOUS Hand shower - Brushed Dark Platinum	28 027 979-99 0010
---	---	-----------------------

Required miscellaneous

	Hand shower FlowReduce - Brushed Dark Platinum	28 016 979-99 0010
---	---	-----------------------

Required miscellaneous

	Hand shower FlowReduce - Brushed Dark Platinum	28 012 979-99 0010
---	---	-----------------------

Required miscellaneous

	Hand shower - Brushed Dark Platinum	28 018 979-99
---	--	---------------

Required miscellaneous

	SERIES-VARIOUS Hand shower - Brushed Dark Platinum	28 029 979-99 0010
---	---	-----------------------

Required miscellaneous

	SERIES-VARIOUS Hand shower - Brushed Dark Platinum	28 025 979-99 0010
---	---	-----------------------

Showerpipe with shower thermostat without hand shower - Brushed Dark Platinum

34 460 979
mm [inches]
1:10

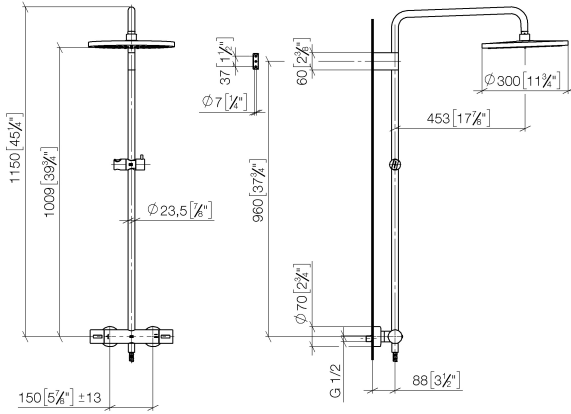

Flow rate chart

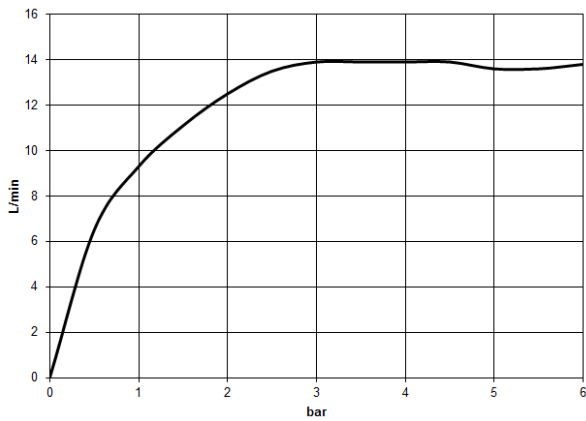

Codes & Standards

DIN 4109

EN 1111

EN 1717

ISO 3822

Scottish Water
Byelaws

UK Water Supply
Regulations

Ü-Zeichen



Showerpipe with shower thermostat without hand shower - Brushed Dark
Platinum

IMO

34 460 979

Certificates

WRAS_2204

DVGW_DW-
6509DN0

Belgaqua_21-032-2 LGA_38

Showerpipe with shower thermostat without hand shower - Brushed Dark Platinum

IMO

34 460 979

Product version from 4/1/2024

Parts for other finishes can be found here: [Chrome](#)

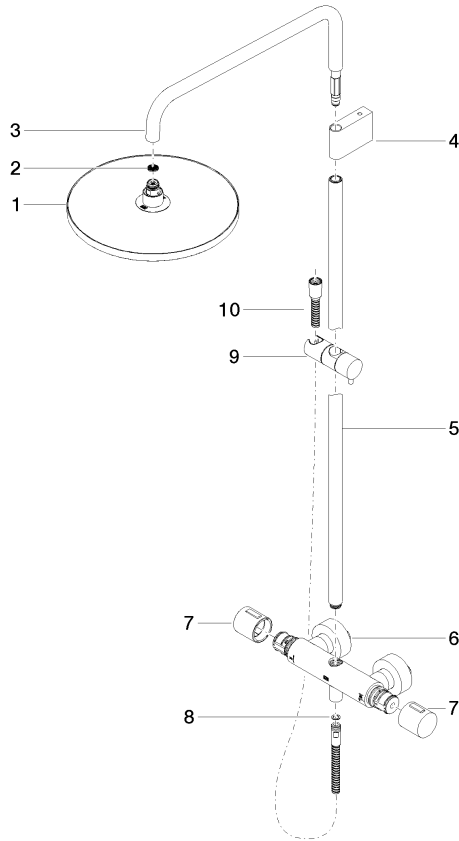



Showerpipe with shower thermostat without hand shower - Brushed Dark
Platinum

IMO

34 460 979

Spare parts list

Product version from 4/1/2024

No.	Item Number	Name	Quantity used	Delivery time
	04 12 05 091 00-99	shower	11	30