

Concealed single-lever mixer with integrated shower connection with shower set without hand shower - Brushed Platinum

IMO

36 110 970















- metal shower hose 1750mm with integrated anti-twist protection
- slide bar
- Pipe diameter 18 mm
- WRAS 2011027

This article does not include a hand shower!
Intrinsic protection against back flow.

This article does not include a hand shower!

Intrinsic protection against back flow.

Fits: IMO, LULU, MADISON, MEM, TARA, CL.1, LISSÉ, VAIA, META, CYO

	Brushed Platinum	36 110 970-06
	Chrome	36 110 970-00
	Platinum	36 110 970-08
	Dark Chrome	36 110 970-19
	Brushed Light Gold	36 110 970-27
	Brushed Durabronze (23kt Gold)	36 110 970-28
	Matte Black	36 110 970-33
	Brushed Bronze	36 110 970-42
	Brushed Champagne (22kt Gold)	36 110 970-46
	Champagne (22kt Gold)	36 110 970-47
	Brushed Chrome	36 110 970-93
	Brushed Dark Platinum	36 110 970-99

Concealed single-lever mixer with integrated shower connection with shower set without hand shower - Brushed Platinum

IMO

36 110 970

Required miscellaneous



Concealed wall mounting - 35 050 970 90
 •max. recess depth 105 mm
 •min. recess depth 80 mm

Required miscellaneous



Hand shower - Brushed Platinum 28 017 979-06

Required miscellaneous



Hand shower - Brushed Platinum 28 016 979-06

Required miscellaneous



Hand shower - Brushed Platinum 28 018 979-06

Required miscellaneous



SERIES-VARIOUS Hand shower - 28 029 979-06
Brushed Platinum

Required miscellaneous



SERIES-VARIOUS Hand shower - 28 027 979-06
Brushed Platinum 0010

Required miscellaneous



Hand shower FlowReduce - 28 016 979-06
Brushed Platinum 0010

Required miscellaneous



Hand shower FlowReduce - 28 012 979-06
Brushed Platinum 0010

Required miscellaneous



Hand shower - Brushed Platinum 28 012 979-06

Required miscellaneous



Hand shower FlowReduce - 28 018 979-06
Brushed Platinum 0010

Required miscellaneous



SERIES-VARIOUS Hand shower - 28 029 979-06
Brushed Platinum 0010

Required miscellaneous



SERIES-VARIOUS Hand shower - 28 025 979-06
Brushed Platinum 0010

Concealed single-lever mixer with integrated shower connection with shower set without hand shower - Brushed Platinum

36 110 970
mm [inches]

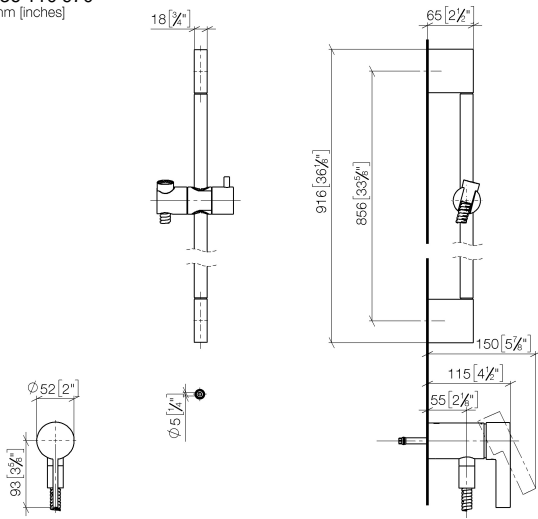

Codes & Standards

DIN 4109	EN 1717	ISO 3822	Scottish Water Byelaws
UK Water Supply Regulations	Ü-Zeichen		

Certificates

Belgaqua_21-025-2 WRAS_2011 LGA_29

Concealed single-lever mixer with integrated shower connection with shower set without hand shower - Brushed Platinum

IMO

36 110 970

Product version from 10/1/2023

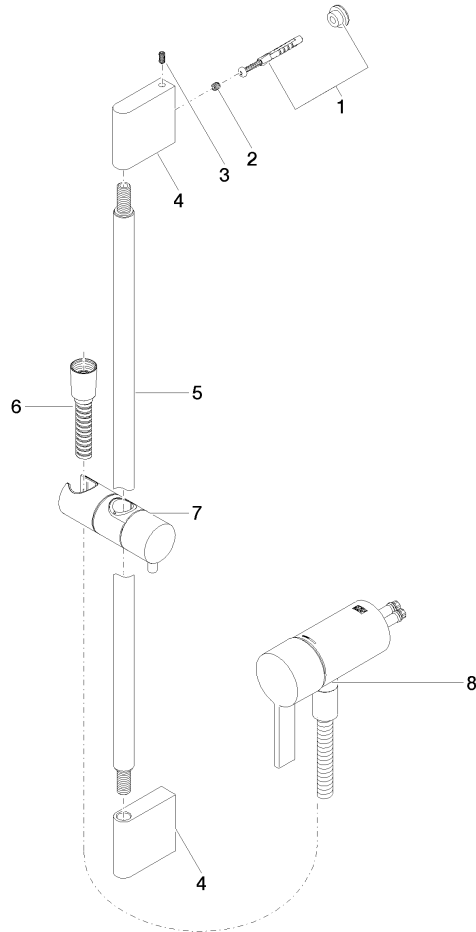



Concealed single-lever mixer with integrated shower connection with shower set without hand shower - Brushed Platinum

IMO

36 110 970

Spare parts list

Product version from 10/1/2023

No.	Item Number	Name	Quantity used	Delivery time
	05 17 20 726 02 90	fixing set	11	2