

**WATER FAN vertical Concealed body spray - Dark Chrome**



IMO

36 513 979



- AQUAPRESSURE FLOW, max. flow rate 10 l/min (at 3 bar)
- water jet adjustable
- cover plate 240 x 60 mm
- 1/2" connection
- WRAS 2005003

Fits: IMO, LULU, MADISON, MEM, TARA, CL.1, LISSÉ, VAIA, META, CYO

	Dark Chrome	36 513 979-19
	Chrome	36 513 979-00
	Brushed Platinum	36 513 979-06
	Platinum	36 513 979-08
	Light Gold	36 513 979-26
	Brushed Light Gold	36 513 979-27
	Brushed Durabronze (23kt Gold)	36 513 979-28
	Matte Black	36 513 979-33
	Brushed Bronze	36 513 979-42
	Brushed Champagne (22kt Gold)	36 513 979-46
	Champagne (22kt Gold)	36 513 979-47
	Brushed Chrome	36 513 979-93
	Brushed Dark Platinum	36 513 979-99

**Required miscellaneous**

- |   |  |               |
|---|--|---------------|
|  | <b>Concealed wall installation box -</b> | 35 206 970 90 |
|   | • max. recess depth 173 mm               |               |
|   | • min. recess depth 100 mm               |               |

**Recommended miscellaneous**

- |   |  |               |
|---|--|---------------|
|  | <b>xGRID Attachment set for integrating in the dry wall construction -</b> | 12 340 970 90 |
|---|--|---------------|

**Required miscellaneous**

- |   |  |               |
|---|--|---------------|
|  | <b>xGRID Installation track 555 mm -</b> | 12 360 970 90 |
|---|--|---------------|

36 513 979

mm [inches]

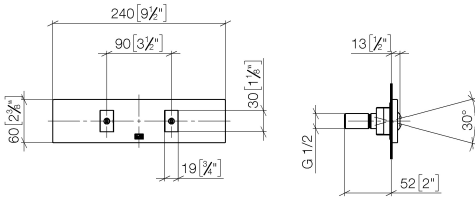

**Flow rate chart**



**Trajectory diagram**

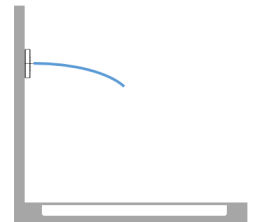
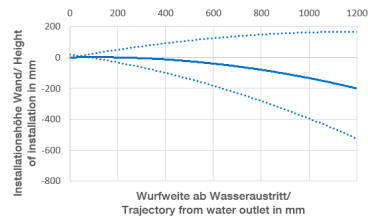

**Codes & Standards**

DIN 4109

ISO 3822

Ü-Zeichen



## WATER FAN vertical Concealed body spray - Dark Chrome

---

IMO

36 513 979

Certificates

---

LGA\_29

36 513 979

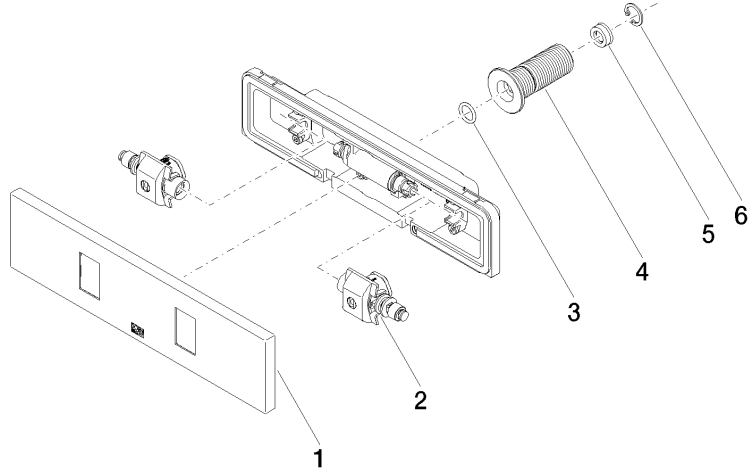



## WATER FAN vertical Concealed body spray - Dark Chrome

---

IMO

36 513 979

### **Spare parts list**