

CYO Wall valve clockwise closing 1/2" - Brushed Dark Platinum







CYO

36 607 811



- without rosette
- handle Ø 60mm
- head part with cut-to-length spindle and sleeve

NOTE: The handle inserts must be ordered separately from the fittings!

	Brushed Dark Platinum	36 607 811-99
	Chrome	36 607 811-00
	Brushed Platinum	36 607 811-06
	Dark Chrome	36 607 811-19
	Brushed Durabronze (23kt Gold)	36 607 811-28
	Platinum / Brushed Platinum	36 607 811-36
	Durabronze / Brushed Durabronze (23kt Gold)	36 607 811-38



CYO Wall valve clockwise closing 1/2" - Brushed Dark Platinum

CYO

36 607 811

mm [inches]

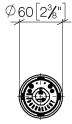

Codes & Standards

ASME A112.18.1

cUPC

DIN 4109

ISO 3822

Ü-Zeichen

Certificates

IAPMO_4976

LGA_38

36 607 811

Parts for other
finishes can be found
here: [Chrome](#)

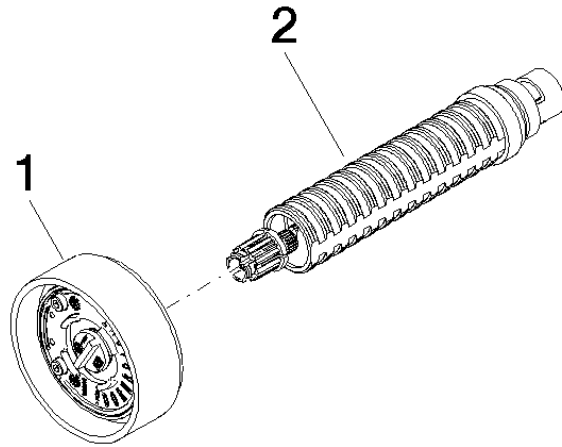



CYO Wall valve clockwise closing 1/2" - Brushed Dark Platinum

CYO

36 607 811

Spare parts list

No.	Item Number	Name	Quantity used	Delivery time
	90 18 40 291 01-99	handle	2	30