

VAIA Wall valve clockwise closing 1/2" - Platinum

VAIA

36 607 819



- rosette Ø 60 mm
- head part with cut-to-length spindle and sleeve
- WRAS 2011026, 2010066

	Platinum	36 607 819-08
	Chrome	36 607 819-00
	Brushed Platinum	36 607 819-06
	Dark Chrome	36 607 819-19
	Brushed Durabronze (23kt Gold)	36 607 819-28
	Brushed Bronze	36 607 819-42
	Brushed Champagne (22kt Gold)	36 607 819-46
	Champagne (22kt Gold)	36 607 819-47
	Brushed Dark Platinum	36 607 819-99

Required miscellaneous



Wall valve 1/2" -

35 607 970 90

- max. recess depth 145 mm
- min. recess depth 75 mm

36 607 819

mm [inches]

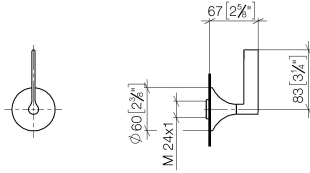

Codes & Standards

ASME A112.18.1	cUPC	DIN 4109	EN 1111
EN 200	ISO 3822	Scottish Water Byelaws	UK Water Supply Regulations

Ü-Zeichen

Certificates

DVGW_DW-6501DN0	IAPMO_4976	WRAS_2010	LGA_29	LGA_29
DVGW_DW-6512DN0	WRAS_2011			

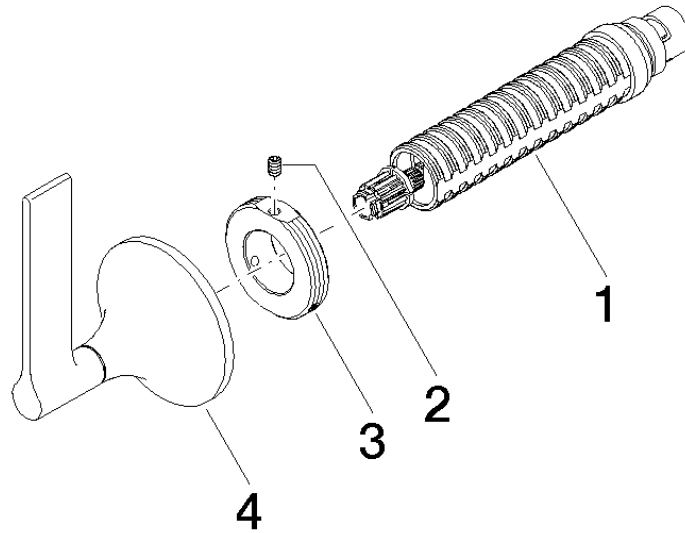



VAIA Wall valve clockwise closing 1/2" - Platinum

VAIA

36 607 819

Spare parts list

No.	Item Number	Name	Quantity used	Delivery time
	90 90 03 143 00 90	top	4	2