







**SYMETRICS Wall valve anti-clockwise closing 1/2" - Platinum**

IMO

36 607 985

- rosette 60 x 60 mm
- head part with cut-to-length spindle and sleeve



	Platinum	36 607 985-08
	Chrome	36 607 985-00
	Brushed Platinum	36 607 985-06
	Brushed Light Gold	36 607 985-27
	Brushed Durabronze (23kt Gold)	36 607 985-28
	Brushed Chrome	36 607 985-93
	Brushed Dark Platinum	36 607 985-99

**Required miscellaneous**

**Wall valve 1/2" -** 35 607 970 90



- max. recess depth 145 mm
- min. recess depth 75 mm

36 607 985

mm [inches]

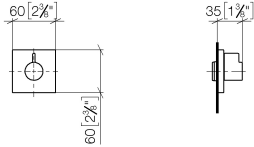

Certificates

DVGW\_DW-  
6501DN0116.

WRAS\_2011026.

IAPMO\_4976 (2).

LGA\_29931.

WRAS\_2010066.

DVGW\_DW-  
6512DN0706.

LGA\_29932.

36 607 985

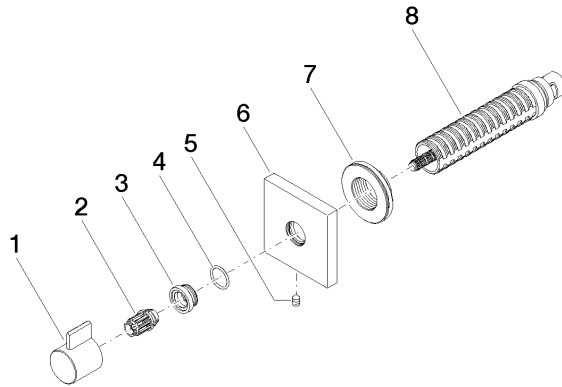

### Spare parts list

No.	Item Number	Name	Quantity used	Delivery time
1	09 20 98 002-08	handle	1	40
2	09 12 12 005 90	fixing cap	1	2
3	09 12 12 043-08	base	1	40
4	09 14 10 017 90	seal	1	2
5	90 31 11 004 00 90	pin	1	2
6	09 27 98 014-08	rosette	1	40
7	09 21 02 151 90	sleeve	1	2
8	90 90 03 202 00 90	top	1	2