







36 860 845



- 170mm projection
- fixed spout
- circular, air-enriched flow
- hole diameter spout 37 mm
- hole diameter single-lever mixer 57 mm
- rosette 78 x 78 mm
- max. flow 5.7 l/min
- lead-free
- This product can help a building meet the requirements of Green Building Rating Systems, e.g. LEED®, BREEAM®, DGNB
- WRAS 2107018

	Chrome	36 860 845-00
	Brushed Platinum	36 860 845-06
	Dark Chrome	36 860 845-19
	Matte Black	36 860 845-33
	Brushed Chrome	36 860 845-93
	Brushed Dark Platinum	36 860 845-99

Required miscellaneous

- | | | |
|---|--|---------------|
|  | Concealed wall-mounted single-lever mixer mixer on right - | 35 816 970 90 |
| | ●NOTE:Not suitable for concealed installation.Connection by means of angle valves, mounted with screws to back wall. | |

Required miscellaneous

- | | | |
|---|--|---------------|
|  | Concealed wall-mounted single-lever mixer - | 35 860 970 90 |
| | ●max. recess depth 95 mm | |
| | ●min. recess depth 80 mm | |

36 860 845

mm [inches]

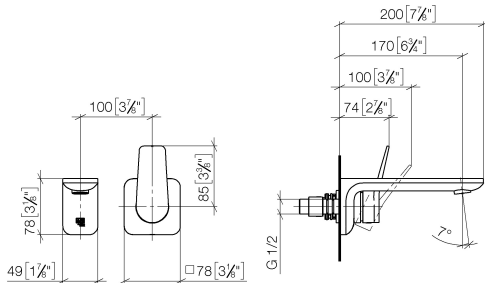

Flow rate chart



Codes & Standards

ASME A112.18.1	cUPC	DIN 4109	EN 817
EPA WaterSense	ISO 3822	NSF372	NSF61
Scottish Water Byelaws	UK Water Supply Regulations	Ü-Zeichen	WaterSense 



LISSÉ Wall-mounted single-lever basin mixer without pop-up waste - Chrome

LISSÉ

36 860 845

Certificates

IAPMO_4976

WRAS_2107

IAPMO_8834

IAPMO_6397

IAPMO_N-4976

DVGW_DW-
6512DN0

LGA_29

36 860 845

Product version from 4/1/2024

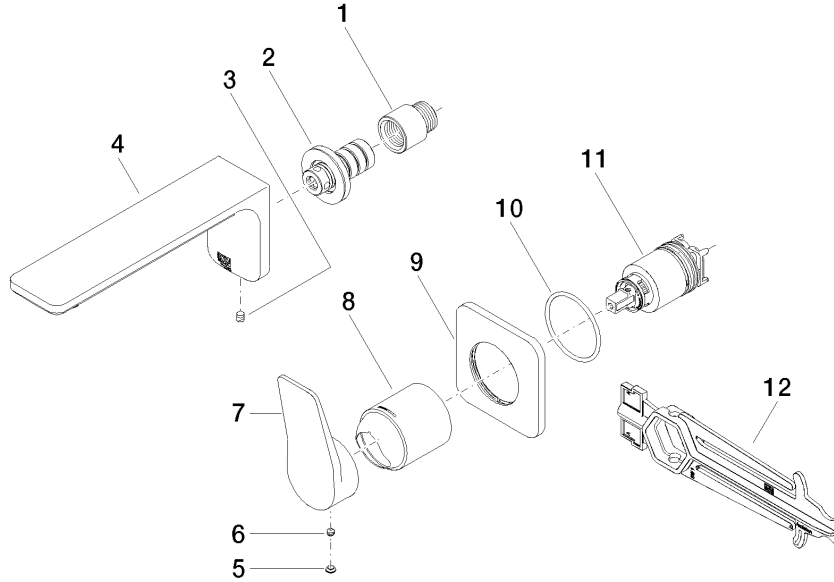



LISSÉ Wall-mounted single-lever basin mixer without pop-up waste - Chrome

LISSÉ

36 860 845

Spare parts list

Product version from 4/1/2024

No.	Item Number	Name	Quantity used	Delivery time
	09 24 03 072 10 90	nipple	12	2