







ST 060 113 2985



- cover plate 120 x 120 mm
- rosette 60 x 60 mm
- temperature control handle with safety limit stop at 38°C
- thermostat cartridge
- 2x head part with cut-to-length spindle and sleeve

	Brushed Platinum	ST 060 113 2985-06
	Chrome	ST 060 113 2985-00
	Platinum	ST 060 113 2985-08
	Brushed Light Gold	ST 060 113 2985-27
	Brushed Durabronze (23kt Gold)	ST 060 113 2985-28
	Brushed Chrome	ST 060 113 2985-93
	Brushed Dark Platinum	ST 060 113 2985-99

**Individual components of this set**

You need the following components for this set

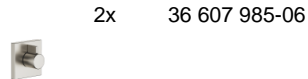
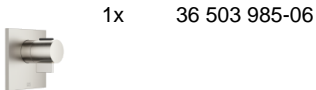



# SYMETRICS xTOOL Thermostat module - Brushed Platinum

---

IMO

ST 060 113 2985

ST 060 113 2985



- cover plate 120 x 120 mm
- temperature control handle with safety limit stop at 38°C
- thermostat cartridge

Fits: IMO, MEM, CL.1, CYO

	Brushed Platinum	36 503 985-06
	Chrome	36 503 985-00
	Platinum	36 503 985-08
	Dark Chrome	36 503 985-19
	Brushed Light Gold	36 503 985-27
	Brushed Durabronze (23kt Gold)	36 503 985-28
	Matte Black	36 503 985-33
	Brushed Champagne (22kt Gold)	36 503 985-46
	Champagne (22kt Gold)	36 503 985-47
	Brushed Chrome	36 503 985-93
	Brushed Dark Platinum	36 503 985-99

**Required miscellaneous**



**xTOOL Concealed thermostat module without volume control -** 35 503 970 90  
 • max. recess depth 160 mm  
 • min. recess depth 95 mm

**Recommended miscellaneous**



**xGRID Attachment set for integrating in the dry wall construction -** 12 340 970 90

**Required miscellaneous**



**xGRID Installation track 555 mm -** 12 360 970 90

ST 060 113 2985

mm [inches]

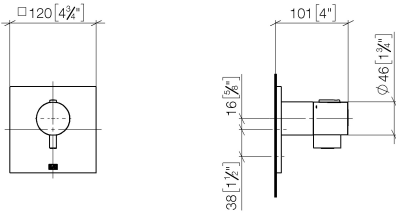

**Flow rate chart**

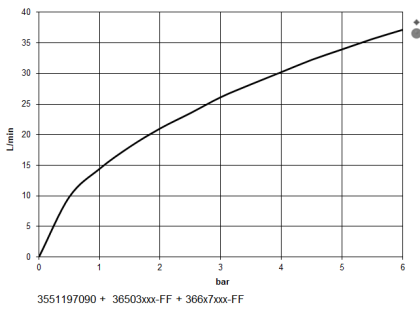

**Certificates**

WRAS\_2011026.

DVGW\_DW-  
6512DN0706.

LGA\_29930.

LGA\_29932.

ST 060 113 2985

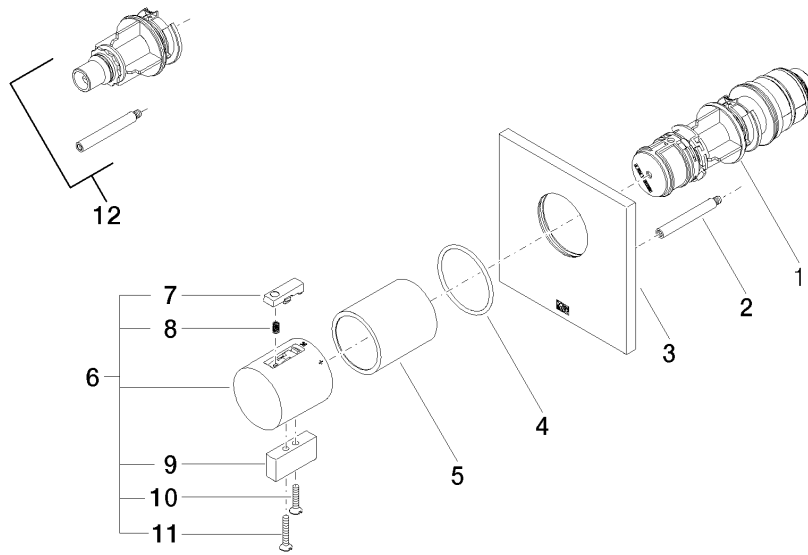







**Spare parts list**

No.	Item Number	Name	Quantity used	Delivery time
1	90 15 02 063 00 90	cartridge	1	2
2	90 31 09 095 00 90	bar	1	2
3	09 11 02 196-06	cover	1	60
4	90 14 10 049 00 90	seal	1	2
5	90 21 02 112 00-06	sleeve	1	10
6	04 17 33 006 00-06	handle	1	60
7	90 21 33 011 00-13	handle	1	2
8	90 16 02 027 00 90	spring	1	2
9	09 20 33 006-06	handle	1	10
10	09 30 30 159-06	screw	1	10
11	09 30 30 160-06	screw	1	10
12	12 178 970 90	Extension 46 mm -	1	2

ST 060 113 2985

- rosette 60 x 60 mm
- head part with cut-to-length spindle and sleeve



	Brushed Platinum	36 607 985-06
	Chrome	36 607 985-00
	Platinum	36 607 985-08
	Brushed Light Gold	36 607 985-27
	Brushed Durabronze (23kt Gold)	36 607 985-28
	Brushed Chrome	36 607 985-93
	Brushed Dark Platinum	36 607 985-99

**Required miscellaneous**

	<b>Wall valve 1/2" -</b> <ul style="list-style-type: none"> <li>•max. recess depth 145 mm</li> <li>•min. recess depth 75 mm</li> </ul>	35 607 970 90
---	---	---------------



# SYMETRICS xTOOL Thermostat module - Brushed Platinum

---

IMO

ST 060 113 2985

ST 060 113 2985

mm [inches]

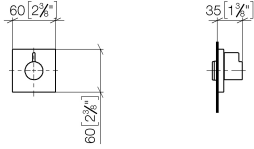

Certificates

DVGW\_DW-  
6501DN0116.

WRAS\_2011026.

IAPMO\_4976 (1).

LGA\_29931.

WRAS\_2010066.

DVGW\_DW-  
6512DN0706.

LGA\_29932.



ST 060 113 2985

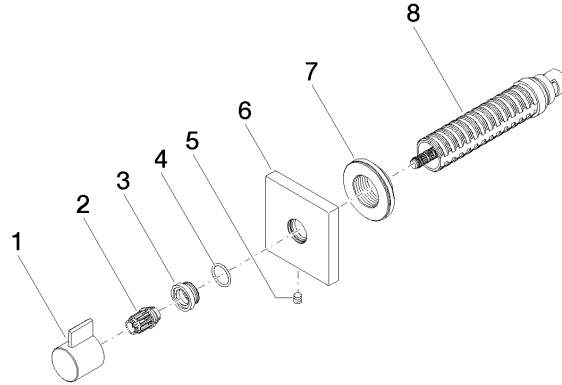

**Spare parts list**

No.	Item Number	Name	Quantity used	Delivery time
1	09 20 98 002-06	handle	1	10
2	09 12 12 005 90	fixing cap	1	2
3	09 12 12 043-06	base	1	10
4	09 14 10 017 90	seal	1	2
5	90 31 11 004 00 90	pin	1	2
6	09 27 98 014-06	rosette	1	10
7	09 21 02 151 90	sleeve	1	2
8	90 90 03 202 00 90	top	1	2