













WATER SHEET Cascade spout for wall-mounted installation - Matte Black

13 415 979 Product version from 10/1/2023



- 5-7/8" Projection
- CASCADE, flow rate max. 7 gpm (at 3 bar)
- Cover plate 9-1/2" x 2-3/8"
- 1/2" connection
- Plug-in connection mounting

	Matte Black	13 415 979-33
	Chrome	13 415 979-00
	Brushed Platinum	13 415 979-06
	Platinum	13 415 979-08
	Dark Chrome	13 415 979-19
	Light gold	13 415 979-26
	Brushed Light Gold	13 415 979-27
	Brushed Durabronze (23kt Gold)	13 415 979-28
	Brushed Bronze	13 415 979-42
	Brushed Champagne (22kt Gold)	13 415 979-46
	Champagne (22kt Gold)	13 415 979-47
	Brushed Chrome	13 415 979-93
	Brushed Dark Platinum	13 415 979-99

Required article

Rough-in adapter -

35 080 970-90
0010



WATER SHEET Cascade spout for wall-mounted installation - Matte Black

13 415 979 Product version from 10/1/2023

mm [inches]

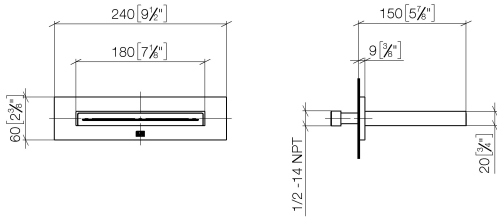

Flow rate chart

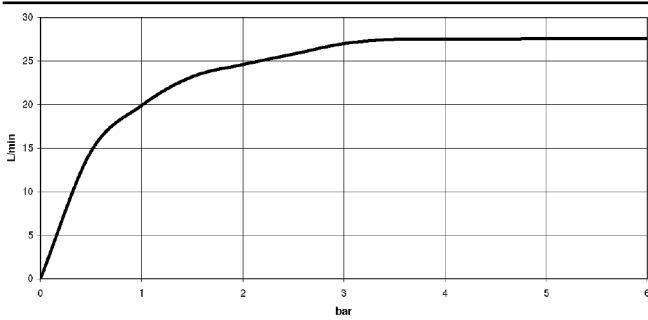

Trajectory length diagram

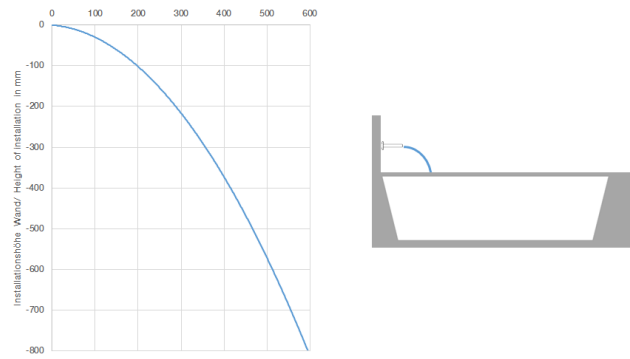

Codes & Standards

ASME A112.18.1	ASME A112.18.1/CSA B125.1	cUPC	DIN 4109
ISO 3822	Scottish Water Byelaws	UK Water Supply Regulations	Ü-Zeichen



WATER SHEET Cascade spout for wall-mounted installation - Matte Black

13 415 979 Product version from 10/1/2023

Certificates

LGA_19

WRAS_2306

IAPMO_4976

WATER SHEET Cascade spout for wall-mounted installation - Matte Black

13 415 979 Product version from 10/1/2023

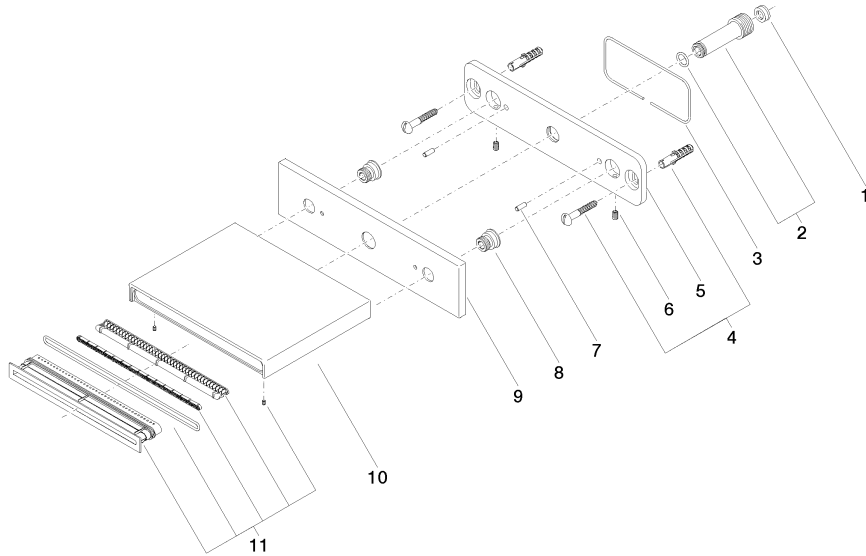

Spare parts list

Number	Item Number	Designation	Number of units	Lead time
1	09 23 01 057 90	flow reducer	1	2
2	90 24 03 213 00 90	connection	1	2
3	09 14 03 134 90	seal	1	2
4	04 30 31 024 01 90	fixing set	1	2
5	09 17 97 059 90	holder	1	2
6	09 31 11 036 90	pin	2	2
7	09 31 11 040 90	pin	2	2
8	09 24 03 214 90	nipple	2	2
9	09 27 78 031-33	rosette	1	30
10	09 11 78 003 20-33	spout	1	30
11	90 29 03 059 00 90	insert	1	2