









IMO Single-lever tub mixer With standpipe for freestanding installation with hand shower set - Chrome

25 863 671



- 11" Projection
- Spout: Cascade
- Hand-held shower: COMPACT RAIN, flow rate max. 1.8 gpm (at 3 bar)
- Baton hand shower with descaling system
- Hand shower bracket
- Integrated diverter
- Total height 37-1/8" - 39-7/8"
- Lower body height 21-5/8" - 24-3/8"
- Height to aerator/spout outlet 35-1/8" - 37-7/8"
- Metal shower hose 49-1/4" with anti-twist device
- Handshower flow rate max. 1.8 gpm
- Flanges Ø 5-3/8"

	Chrome	25 863 671-00
	Brushed Platinum	25 863 671-06
	Dark Chrome	25 863 671-19
	Brushed Light Gold	25 863 671-27
	Matte Black	25 863 671-33
	Brushed Chrome	25 863 671-93
	Brushed Dark Platinum	25 863 671-99

Required article



- Floor mounting rough set -** 35 949 970-90
- Min. rough in depth "
 - Max. rough in depth "

IMO Single-lever tub mixer With standpipe for freestanding installation with hand shower set - Chrome

25 863 671

mm [inches]

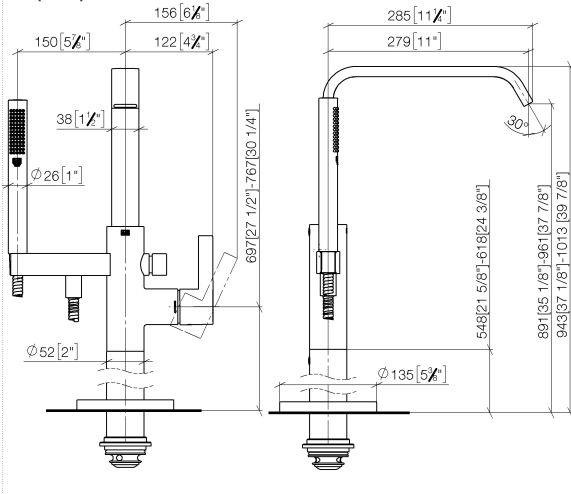

Flow rate chart

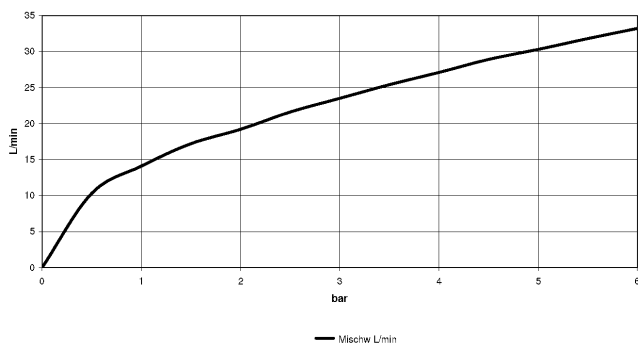

Codes & Standards

DIN 4109

ISO 3822

Ü-Zeichen



IMO Single-lever tub mixer With standpipe for freestanding installation with
hand shower set - Chrome

25 863 671

Certificates

LGA_38

IMO Single-lever tub mixer With standpipe for freestanding installation with hand shower set - Chrome

25 863 671

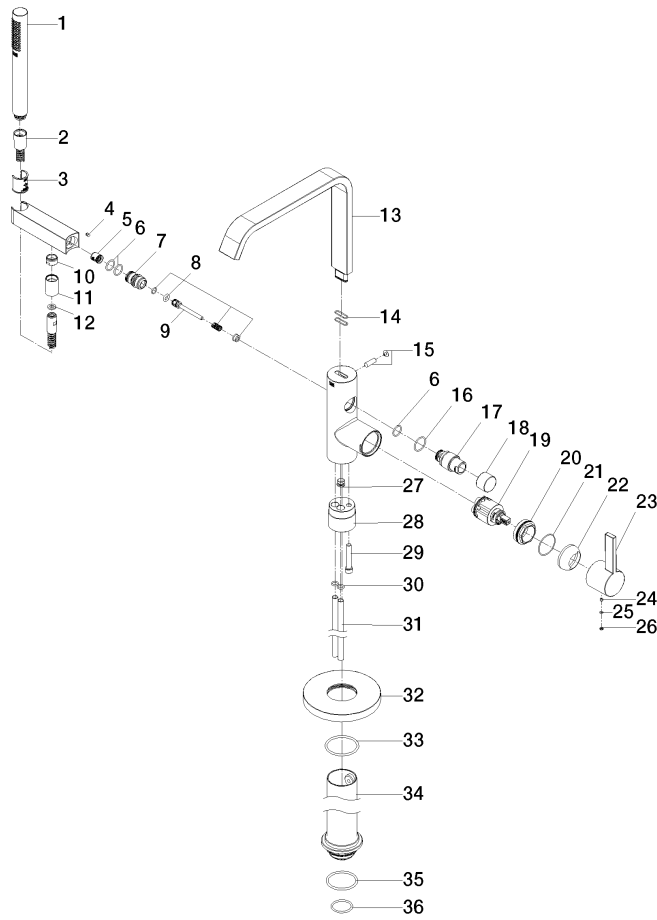



IMO Single-lever tub mixer With standpipe for freestanding installation with hand shower set - Chrome

25 863 671

Spare parts list

Number	Item Number	Designation	Number of units	Lead time
1	90 12 11 140 41-00	shower	1	10
2	90 30 02 072 00-00	Metal shower hose 1/2" x 3/8" x 49-1/4" - Chrome	1	10
3	09 18 40 118 90	sleeve	1	2
4	09 31 11 058 90	pin	1	2
5	90 23 01 141 00 90	back-flow preventer	1	2
6	90 14 10 010 00 90	seal	3	2
7	09 24 03 153 20-00	nipple	1	10
8	90 16 02 023 00 90	spring	1	2
9	09 31 09 102 20-00	pull-rod	1	10
10	09 24 03 069 90	nipple	1	2
11	90 21 02 069 00-00	cover	1	10
12	09 14 03 066 90	seal	1	2
13	90 28 22 408 00-00	spout	1	-
Spare part can no longer be ordered, please order the replacement item				
14	09 14 10 096 90	seal	2	2
15	04 31 20 036 00 90	plug	1	2
16	09 14 10 112 90	seal	1	2
17	09 21 34 081 20-00	nipple	1	10
18	09 20 88 002-00	handle	1	10
19	90 15 05 039 00 90	cartridge	1	2
20	09 24 04 298 90	nut	1	2
21	09 14 10 190 90	seal	1	2
22	09 28 30 036-00	cover	1	10
23	09 20 67 014-00	handle	1	10
24	90 31 11 030 00 90	pin	1	2
25	09 14 10 133 90	seal	1	2
26	09 31 20 087-00	plug	1	10
27	04 31 20 039 11 90	plug	1	2
28	09 24 03 152 20-00	adaptor	1	10
29	09 30 30 111 90	screw	1	2
30	09 14 10 139 90	seal	4	2
31	04 28 22 025 00 90	connection	2	2
32	09 27 88 007-00	rosette	1	10
33	90 14 10 129 00 90	seal	1	2
34	04 28 22 030 00-00	pipe	1	10
35	09 14 10 084 90	seal	1	2
36	09 14 10 018 90	seal	1	2