

**WATER TUBE Kneipp wall elbow with hose bracket with individual flanges -  
Chrome**

27 823 979 Product version from 10/1/2023





























- LAMINAR FLOW, max. flow rate 4 gpm (at 3 bar)
- with volume control
- Flange diameter 2-3/8"
- Bracket for Kneipp hose
- 1/2" wall elbow
- Hose to be ordered separately

**Internal backflow preventer.**

**Product change as of 1.4.2023: Water flow rate limited to max. 4 gpm**

Internal backflow preventer.

Product change as of 1.4.2023: Water flow rate limited to max. 4 gpm

	Chrome	27 823 979-00
	Chrome	27 823 979-00 0010
	Brushed Platinum	27 823 979-06 0010
	Brushed Platinum	27 823 979-06
	Platinum	27 823 979-08 0010
	Platinum	27 823 979-08
	Dark Chrome	27 823 979-19 0010
	Dark Chrome	27 823 979-19
	Light gold	27 823 979-26
	Light gold	27 823 979-26 0010
	Brushed Light Gold	27 823 979-27
	Brushed Light Gold	27 823 979-27 0010
	Brushed Durabrass (23kt Gold)	27 823 979-28 0010
	Brushed Durabrass (23kt Gold)	27 823 979-28
	Matte Black	27 823 979-33 0010
	Matte Black	27 823 979-33
	Brushed Dark Brass	27 823 979-39
	Brushed Bronze	27 823 979-42 0010
	Brushed Bronze	27 823 979-42
	Brushed Champagne (22kt Gold)	27 823 979-46 0010
	Brushed Champagne (22kt Gold)	27 823 979-46
	Champagne (22kt Gold)	27 823 979-47 0010
	Champagne (22kt Gold)	27 823 979-47
	Brushed Chrome	27 823 979-93 0010
	Brushed Chrome	27 823 979-93
	Brushed Dark Platinum	27 823 979-99 0010



# WATER TUBE Kneipp wall elbow with hose bracket with individual flanges - Chrome

27 823 979 Product version from 10/1/2023



27 823 979-99

## Required article

	<b>Rough-in adapter -</b>	35 080 970-90 0010
---	---------------------------	-----------------------

## Required article

	<b>WATER TUBE Kneipp hose white 78-3/4" - Chrome</b>	28 285 979-00
	<ul style="list-style-type: none"><li>●Hose nozzle with sleeve</li><li>●With holding ring</li></ul>	

## Required article

	<b>WATER TUBE Kneipp hose black 78-3/4" - Chrome</b>	28 286 979-00
	<ul style="list-style-type: none"><li>●Hose nozzle with sleeve</li><li>●With holding ring</li></ul>	



# WATER TUBE Kneipp wall elbow with hose bracket with individual flanges - Chrome

27 823 979 Product version from 10/1/2023  
mm [inches]

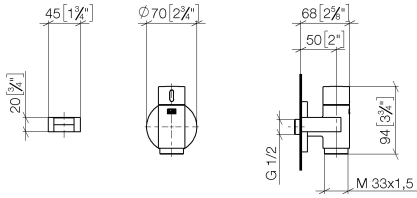

## Flow rate chart

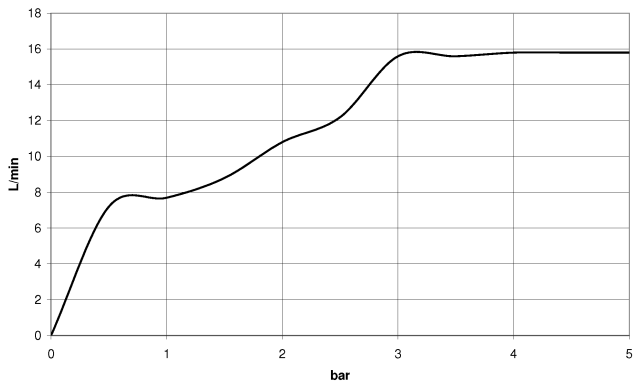

**WATER TUBE Kneipp wall elbow with hose bracket with individual flanges - Chrome**

27 823 979 Product version from 10/1/2023

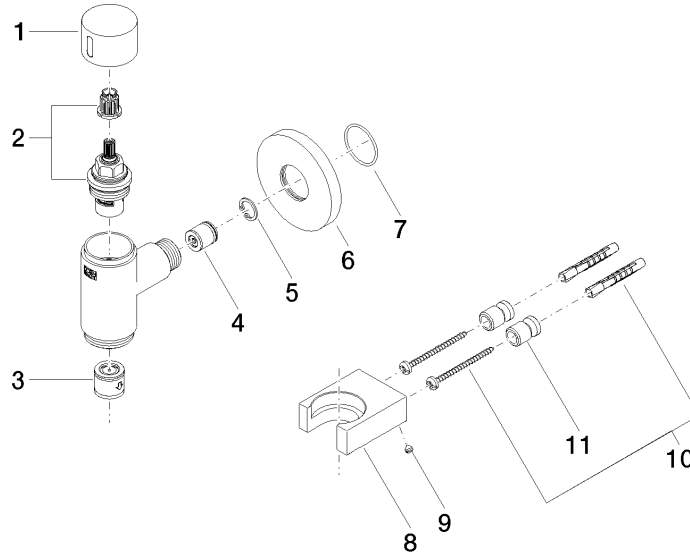

**Spare parts list**

Number	Item Number	Designation	Number of units	Lead time
1	09 20 97 021-00	handle	1	10
2	90 90 03 145 00 90	top	1	2
3	90 23 01 045 00 90	back-flow preventer	1	2
4	09 23 01 046 90	back-flow preventer	1	2
5	09 16 01 014 90	ring	1	2
6	09 27 97 020-00	rosette	1	10
7	09 14 10 135 90	seal	1	2
8	09 17 20 023-00	holder	1	10
9	09 31 11 148 90	pin	1	2
10	05 17 20 726 02 90	fixing set	1	2
11	08 17 20 726 90	holder	1	2