











LISSÉ Wall elbow - Brushed Platinum

28 450 845 Product version from 3/2/2021



- 3/8" Shower outlet
 - Flange 2-3/8" x 3-1/8"
 - 1/2" connection
- Internal backflow preventer.**
- Internal backflow preventer.

	Brushed Platinum	28 450 845-06
	Chrome	28 450 845-00
	Dark Chrome	28 450 845-19
	Light gold	28 450 845-26
	Brushed Light Gold	28 450 845-27
	Matte Black	28 450 845-33
	Brushed Bronze	28 450 845-42
	Brushed Chrome	28 450 845-93
	Brushed Dark Platinum	28 450 845-99

Required article

Rough-in adapter -

35 080 970-90
0010





LISSÉ Wall elbow - Brushed Platinum

28 450 845 Product version from 3/2/2021

mm [inches]

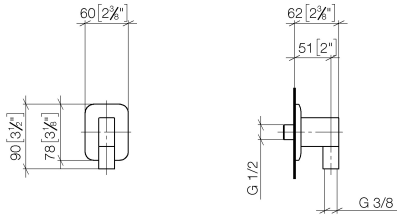

Flow rate chart

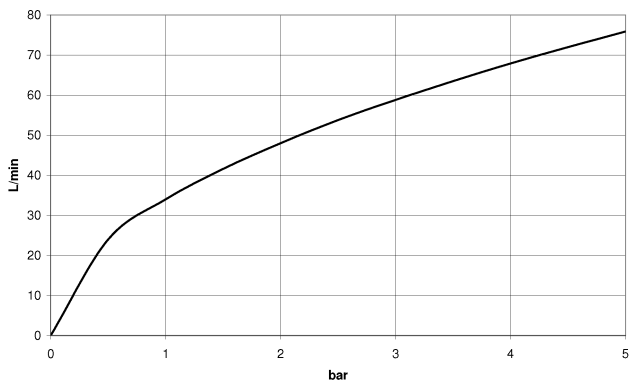

Codes & Standards

ASME A112.18.1

ASME
A112.18.1/CSA
B125.1

cUPC

Scottish Water
Byelaws

UK Water Supply
Regulations



LISSÉ Wall elbow - Brushed Platinum

28 450 845 Product version from 3/2/2021

Certificates

WRAS_2310

IAPMO_4976

LISSÉ Wall elbow - Brushed Platinum

28 450 845 Product version from 3/2/2021

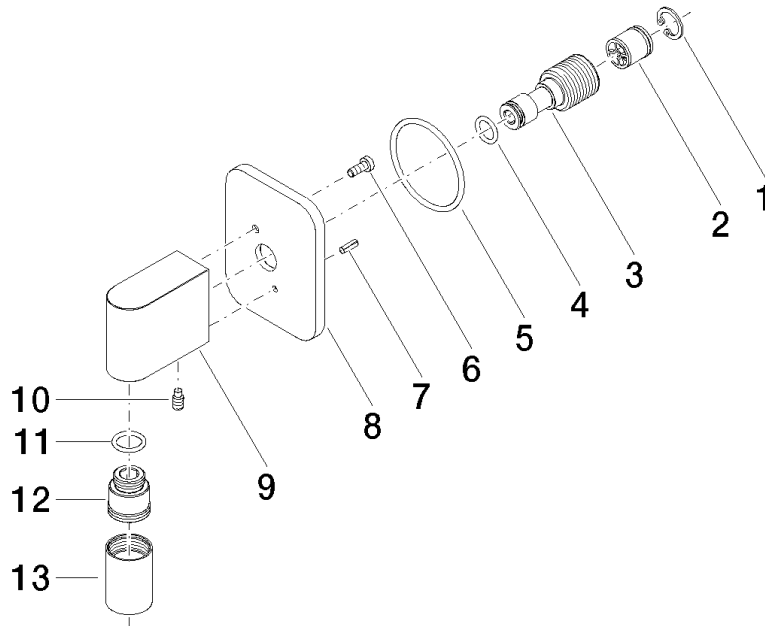

Spare parts list

Number	Item Number	Designation	Number of units	Lead time
1	09 16 01 014 90	ring	1	2
2	90 23 01 141 00 90	back-flow preventer	1	2
3	09 24 03 116 20 90	nipple	1	2
4	09 14 10 008 90	seal	1	2
5	09 14 10 142 90	seal	1	2
6	09 30 30 054 90	screw	1	2
7	09 31 11 026 90	pin	1	2
8	09 27 84 021-06	rosette	1	10
9	09 11 03 046-06	connection	1	10
10	09 31 11 005 90	pin	1	2
11	90 14 10 077 00 90	seal	1	2
12	09 24 03 107 20 90	nipple	1	2
13	90 21 02 069 00-06	cover	1	10