









MADISON Rain shower ceiling-mounted 7-7/8" - Brushed Durabron (23kt Gold)

28 565 977 Product version from 12/5/2019



- Rain shower diameter 7-7/8"
- PURE RAIN, flow rate max. 1.8 gpm (at 3 bar)
- 7-1/4" distance between ceiling and bottom of showerhead
- Flange diameter 2-1/8"
- 1/2" connection
- Descaling system
- This product reduces water consumption by 28% (compared to requirements of EPA Act '92)
- This product can help a building meet the requirements of Green Building Rating Systems, e.g. LEED®, BREEAM®, DGNB

	Brushed Durabron (23kt Gold)	28 565 977-28 0010
	Chrome	28 565 977-00 0010
	Brushed Platinum	28 565 977-06 0010
	Platinum	28 565 977-08 0010
	Durabron (23kt Gold)	28 565 977-09 0010
	Brushed Dark Platinum	28 565 977-99 0010

Required article

	Concealed wall elbow - •Max. rough in depth " •Min. rough in depth "	35 085 970-90 0010
---	---	-----------------------



MADISON Rain shower ceiling-mounted 7-7/8" - Brushed Durabronz (23kt Gold)

28 565 977 Product version from 12/5/2019
mm [inches]

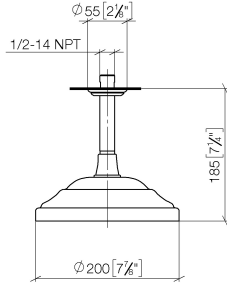

Flow rate chart

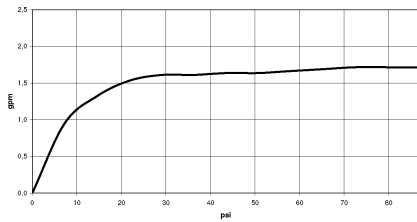

Codes & Standards

ASME A112.18.1/CSA B125.1	California Energy Commission (CEC)
---------------------------------	--

MADISON Rain shower ceiling-mounted 7-7/8" - Brushed Durabronz (23kt Gold)

28 565 977 Product version from 12/5/2019

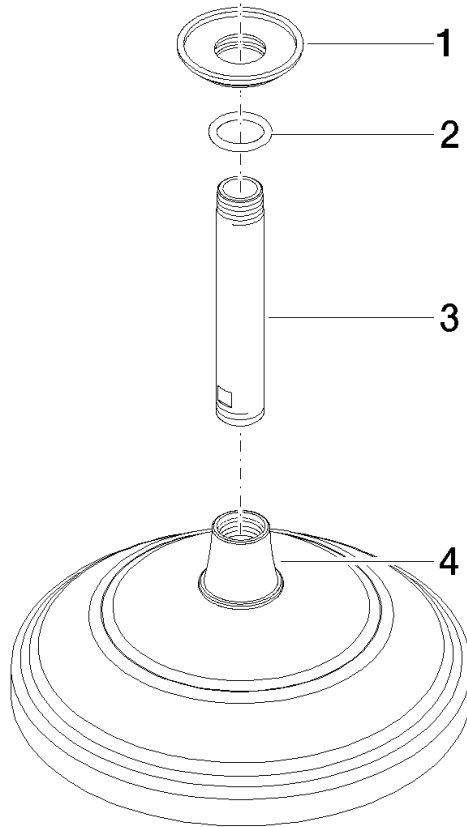

Spare parts list

Number	Item Number	Designation	Number of units	Lead time
1	09 27 35 003-28	rosette	1	60
2	90 14 10 026 00 90	seal	1	2
3	09 11 03 018-28	connection	1	60
4	04 12 05 038 30-28	shower	1	20