















Rain shower wall-mounted 11-3/4" - Brushed Chrome

28 679 970 Product version from 3/13/2017



- 17-3/4" Projection
- PURE RAIN, flow rate max. 1.8 gpm (at 3 bar)
- Function from: 1.7 gpm
- Descaling system
- Rain shower diameter 11-3/4"
- Flange diameter 2-3/8"
- 1/2" connection
- with drip prevention
- This product reduces water consumption by 28% (compared to requirements of EAct '92)
- This product contributes to meeting the requirements of the LEED® Green Building Rating
- This product can help a building meet the requirements of Green Building Rating Systems, e.g. LEED®, BREEAM®, DGNB

	Brushed Chrome	28 679 970-93 0010
	Chrome	28 679 970-00 0010
	Brushed Platinum	28 679 970-06 0010
	Platinum	28 679 970-08 0010
	Dark Chrome	28 679 970-19 0010
	Light gold	28 679 970-26 0010
	Brushed Light Gold	28 679 970-27 0010
	Brushed Durabronze (23kt Gold)	28 679 970-28 0010
	Matte Black	28 679 970-33 0010
	Brushed Bronze	28 679 970-42 0010
	Brushed Champagne (22kt Gold)	28 679 970-46 0010
	Champagne (22kt Gold)	28 679 970-47 0010
	Brushed Dark Platinum	28 679 970-99 0010



Rain shower wall-mounted 11-3/4" - Brushed Chrome

28 679 970 Product version from 3/13/2017

mm [inches]

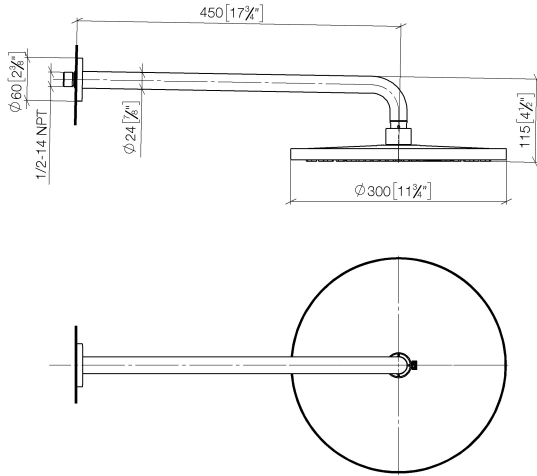

Flow rate chart

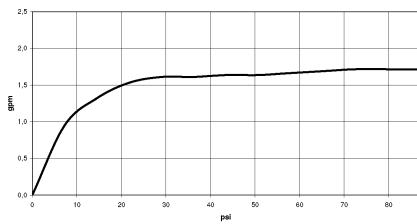

Codes & Standards

ASME A112.18.1	ASME A112.18.1/CSA B125.1	California Energy Commission (CEC)	cUPC
EPA WaterSense	Water Sense	WaterSense	



Rain shower wall-mounted 11-3/4" - Brushed Chrome

28 679 970 Product version from 3/13/2017

Certificates

IAPMO_4976

IAPMO_11777

Rain shower wall-mounted 11-3/4" - Brushed Chrome

28 679 970 Product version from 3/13/2017

Parts for other finishes can be found here: [Chrome](#)

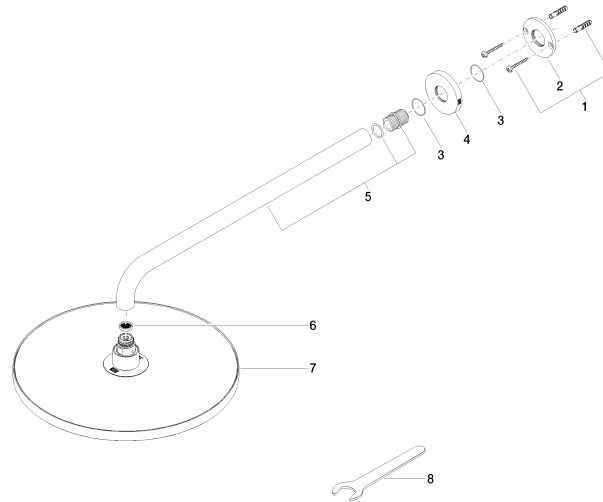

Spare parts list

Number	Item Number	Designation	Number of units	Lead time
1	04 30 31 032 00 90	fixing set	1	2
2	09 17 20 120 90	holder	1	2
3	09 14 10 150 90	seal	2	2
4	09 27 97 015-93	rosette	1	20
5	90 11 03 070 00-93	pipe	1	20
6	09 23 01 075 90	insert	1	2
7	04 12 05 091 10-93	shower	1	20
8	90 30 09 069 00 90	key	1	2