



LISSÉ Single-lever lavatory mixer with drain - Dark Chrome







33 500 845 Product version from 5/3/2021



- 5-1/8" Projection
- US drain with overflow
- Rigid spout
- Round aerated stream
- Total height 5"
- Height to aerator/spout outlet 3"
- 1-3/8" hole diameter
- 2 x pressure hose with 3/8" compression fitting
- Water flow rate limited to max. 1.2 gpm
- lead-free
- This product can help a building meet the requirements of Green Building Rating Systems, e.g. LEED®, BREEAM®, DGNB

Suitable only for basins with overflow.

(ADA)

	Dark Chrome	33 500 845-19 0010
	Chrome	33 500 845-00 0010
	Brushed Platinum	33 500 845-06 0010
	Brushed Light Gold	33 500 845-27 0010
	Matte Black	33 500 845-33 0010
	Brushed Chrome	33 500 845-93 0010
	Brushed Dark Platinum	33 500 845-99 0010



LISSÉ Single-lever lavatory mixer with drain - Dark Chrome

33 500 845 Product version from 5/3/2021

mm [inches]

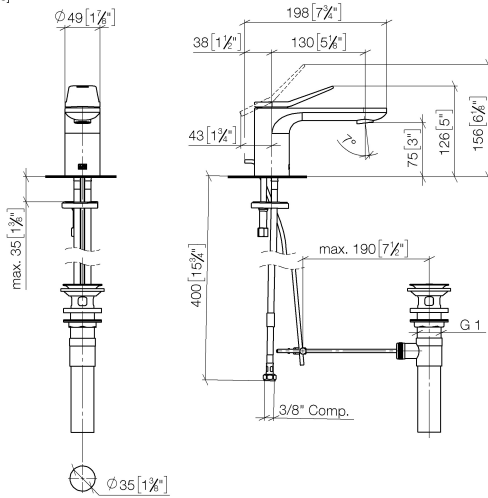

Codes & Standards

ADA	ASME A112.18.1	ASME A112.18.1/CSA B125.1	California Energy Commission (CEC)
cUPC	NSF/ANSI 372	NSF/ANSI/CAN 61	NSF372
NSF61			

Certificates

IAPMO_N-4976 IAPMO_6397 IAPMO_4976 (

LISSÉ Single-lever lavatory mixer with drain - Dark Chrome

33 500 845 Product version from 5/3/2021

Parts for other finishes can be found here: [Chrome](#)

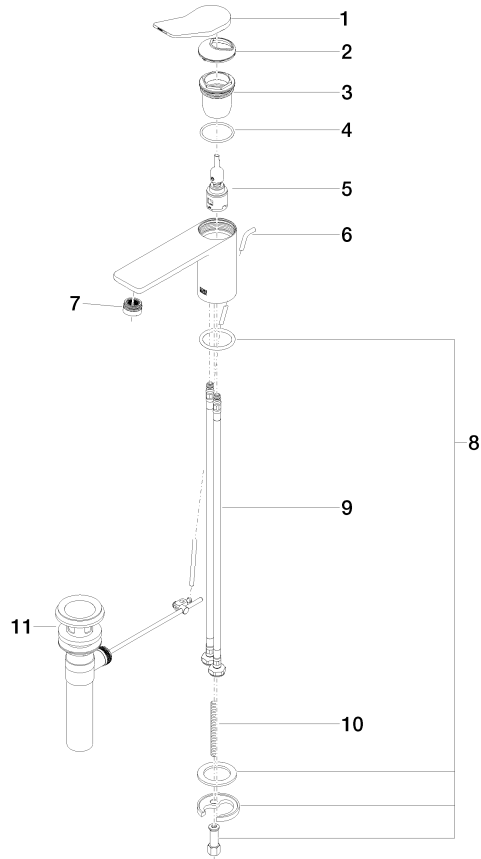

Spare parts list

Number	Item Number	Designation	Number of units	Lead time
1	90 20 84 020 00-19	handle	1	20
2	09 28 30 034 90	cover	1	2
3	09 23 10 123 90	nut	1	2
4	09 14 10 038 90	seal	1	2
5	90 15 05 042 01 90	cartridge	1	2
6	09 31 09 120-19	pull-rod	1	60
7	90 23 01 161 03-19	aerator	1	20
8	04 30 11 038 75 90	fixing set	1	2
9	04 30 04 102 00 90	Flexible supply line 3/8" -	2	2
10	09 31 11 011 90	pin	1	2
11	90 11 01 023 00-19	pop-up waste	1	20