



CL.1 Wall mounted two-way diverter - Chrome

36 200 705 Product version from 4/1/2022









- Manual diverter
- Flange 2-3/8" x 2-3/8"
- with integrated shut-off (ADA)

Does not allow for simultaneous use of functions

(ADA)

Does not allow for simultaneous use of functions

	Chrome	36 200 705-00 0010
	Brushed Platinum	36 200 705-06 0010
	Dark Chrome	36 200 705-19 0010
	Brushed Champagne (22kt Gold)	36 200 705-46 0010
	Champagne (22kt Gold)	36 200 705-47 0010
	Brushed Dark Platinum	36 200 705-99 0010

Required article



- Wall mounted two-way diverter -** 35 202 970-90
•Max. rough in depth " 0010
•Min. rough in depth "



CL.1 Wall mounted two-way diverter - Chrome

36 200 705 Product version from 4/1/2022

mm [inches]

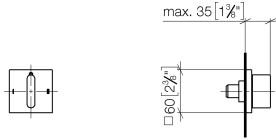

Flow rate chart

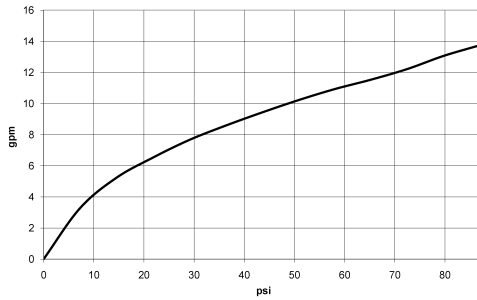

Codes & Standards

ASME A112.18.1

California Energy
Commission
(CEC)

cUPC



CL.1 Wall mounted two-way diverter - Chrome

36 200 705 Product version from 4/1/2022

Certificates

IAPMO_4976 (

CL.1 Wall mounted two-way diverter - Chrome

36 200 705 Product version from 4/1/2022

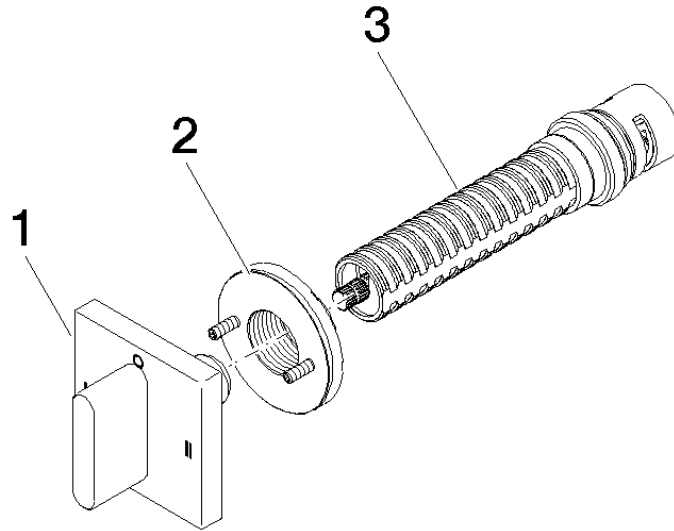

Spare parts list

Number	Item Number	Designation	Number of units	Lead time
1	90 20 70 051 09-00	handle	1	10
2	90 21 02 181 00 90	disc	1	2
3	90 90 03 306 10 90	diverter	1	2