







LISSÉ Wall-mounted single-lever mixer without drain - Chrome

36 860 845 Product version from 4/1/2024



- 6-3/4" Projection
 - Rigid spout
 - Round aerated stream
 - Spout hole diameter 1-1/2"
 - Hole diameter single-lever mixer 2-1/4"
 - Flange 3-1/8" x 3-1/8"
 - Water flow rate limited to max. 1.5 gpm
 - lead-free
 - This product can help a building meet the requirements of Green Building Rating Systems, e.g. LEED®, BREEAM®, DGNB
- (ADA)**

(ADA)

	Chrome	36 860 845-00
	Brushed Platinum	36 860 845-06
	Dark Chrome	36 860 845-19
	Brushed Light Gold	36 860 845-27
	Matte Black	36 860 845-33
	Brushed Chrome	36 860 845-93
	Brushed Dark Platinum	36 860 845-99

Required article



- Rough for wall-mounted faucet -** 35 860 970-90
0010
- Max. rough in depth "
 - Min. rough in depth "
 - Rough can be rotated to position the lever on top or to the left of the spout.



LISSÉ Wall-mounted single-lever mixer without drain - Chrome

36 860 845 Product version from 4/1/2024

mm [inches]

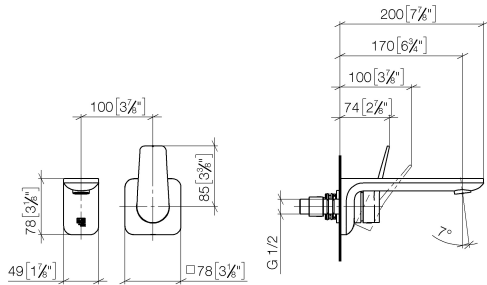

Flow rate chart

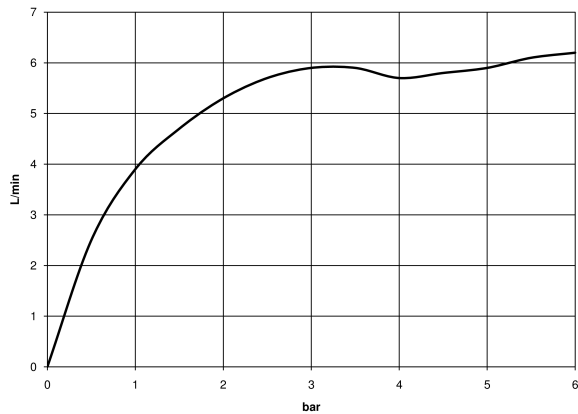

Codes & Standards

ADA	ASME A112.18.1	ASME A112.18.1/CSA B125.1	cUPC
DIN 4109	EN 817	EPA WaterSense	ISO 3822
NSF/ANSI 372	NSF/ANSI/CAN 61	NSF372	NSF61
Scottish Water Byelaws	UK Water Supply Regulations	Ü-Zeichen	Water Sense

WaterSense





LISSÉ Wall-mounted single-lever mixer without drain - Chrome

36 860 845 Product version from 4/1/2024

Certificates

IAPMO_N-4976	DVGW_DW-6512DN0	IAPMO_6397	LGA_29	WRAS_2107
IAPMO_8834	IAPMO_4976 (

LISSÉ Wall-mounted single-lever mixer without drain - Chrome

36 860 845 Product version from 4/1/2024

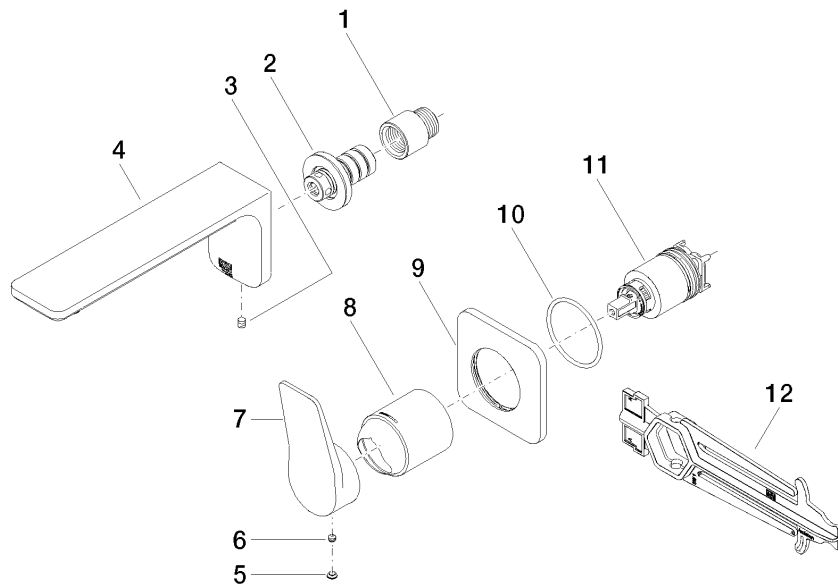

Spare parts list

Number	Item Number	Designation	Number of units	Lead time
1	09 24 03 072 10 90	nipple	1	2
2	90 24 03 108 00 90	nipple set	1	2
3	90 31 11 004 00 90	pin	1	2
4	90 11 84 021 00-00	spout	1	10
5	90 31 20 087 00-00	plug	1	10
6	90 31 11 063 00 90	pin	1	2
7	09 20 84 021-00	handle	1	10
8	09 11 02 288-00	cover	1	10
9	90 27 84 020 00-00	rosette	1	10
10	90 14 10 049 00 90	seal	1	2
11	90 15 05 046 02 90	cartridge	1	2
12	90 30 09 064 00 90	key	1	2