







Pressure Balance Valve without diverter

36 900 845 Product version from 5/1/2024

- Cover plate 3-1/2" x 5-7/8"



	Chrome	36 900 845-00
	Brushed Platinum	36 900 845-06
	Dark Chrome	36 900 845-19
	Brushed Light Gold	36 900 845-27
	Matte Black	36 900 845-33
	Brushed Chrome	36 900 845-93
	Brushed Dark Platinum	36 900 845-99

Required article



Pressure Balance Valve - 35 920 970 90

- Min. rough in depth "
- Max. rough in depth "



Pressure Balance Valve without diverter

36 900 845 Product version from 5/1/2024

mm [inches]

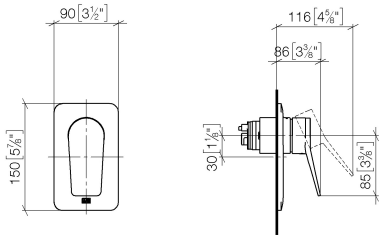

Codes & Standards

ASME A112.18.1

cUPC

Certificates

IAPMO_4976 (

Pressure Balance Valve without diverter

36 900 845 Product version from 5/1/2024

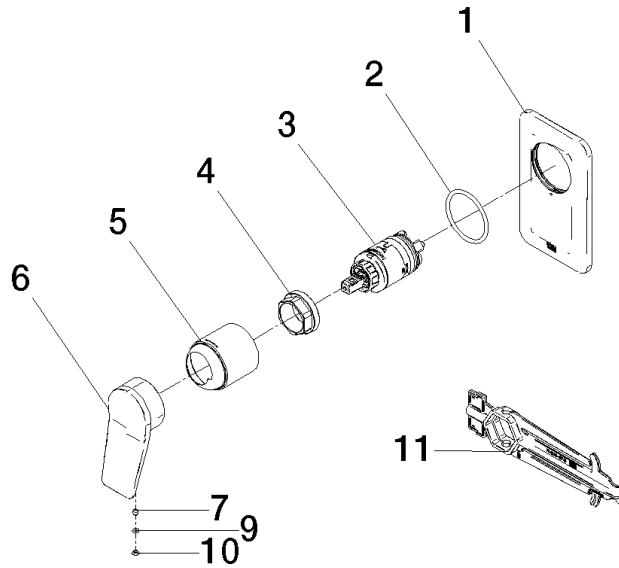

Spare parts list

Number	Item Number	Designation	Number of units	Lead time
1	09 11 02 300-00	plate	1	10
2	09 14 10 084 90	seal	1	2
3	90 15 05 069 00 90	cartridge	1	2
4	09 24 04 448 90	nut	1	2
5	09 11 02 260-00	sleeve	1	10
6	09 20 84 022-00	handle	1	10
7	90 31 11 030 00 90	pin	1	2
9	09 14 10 133 90	seal	1	2
10	09 31 20 087-00	plug	1	10
11	90 30 09 064 00 90	key	1	2