











## Reserve tissue holder - Brushed Durabross (23kt Gold)

83 590 780

- Width 5-1/4"
- Height 1-3/8"
- 4-5/8" Projection



	Brushed Durabross (23kt Gold)	83 590 780-28
	Chrome	83 590 780-00
	Brushed Platinum	83 590 780-06
	Platinum	83 590 780-08
	Dark Chrome	83 590 780-19
	Brushed Champagne (22kt Gold)	83 590 780-46
	Champagne (22kt Gold)	83 590 780-47
	Brushed Dark Platinum	83 590 780-99



## Reserve tissue holder - Brushed Durabronz (23kt Gold)

---

83 590 780

mm [inches]

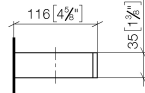
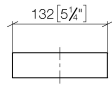

**Reserve tissue holder - Brushed Durabross (23kt Gold)**

83 590 780

Parts for other finishes can be found here: [Chrome](#)

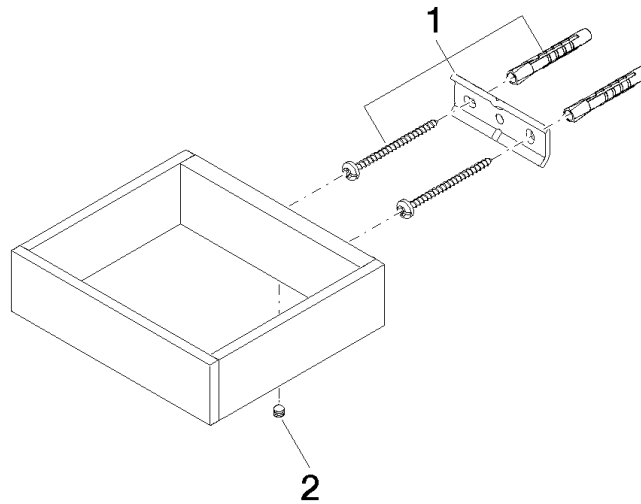

**Spare parts list**

Number	Item Number	Designation	Number of units	Lead time
1	05 17 20 718 00 90	fixing set	1	2
2	90 31 11 112 00 90	pin	1	2