

Wall-mounted basin spout without pop-up waste - Chrome









TARA

13 800 882



Fits: TARA, META

- 190mm projection
  - fixed spout
  - circular, air-enriched flow
  - hole diameter 40 mm
  - rosette Ø 60 mm
  - 1/2" connection
  - plug-link mounting
  - max. flow 4.5 l/min
  - lead-free
  - This product can help a building meet the requirements of Green Building Rating Systems, e.g. LEED®, BREEAM®, DGNB
- For Touchfree control please order eSet Touchfree WITH or WITHOUT temperature adjustment**
- For Touchfree control please order eSet Touchfree WITH or WITHOUT temperature adjustment

	Chrome	13 800 882-00 0010
	Dark Chrome	13 800 882-19 0010
	Brushed Durabronze (23kt Gold)	13 800 882-28 0010
	Brushed Bronze	13 800 882-42 0010
	Brushed Champagne (22kt Gold)	13 800 882-46 0010
	Champagne (22kt Gold)	13 800 882-47 0010
	Brushed Chrome	13 800 882-93 0010
	Brushed Dark Platinum	13 800 882-99 0010

Required miscellaneous

Concealed adapter -

35 080 970-90  
0010



13 800 882

mm [inches]

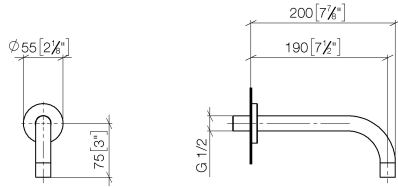

Flow rate chart

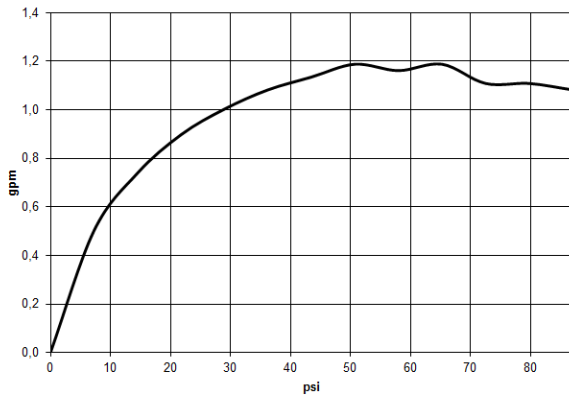

Codes & Standards

ASME  
A112.18.1/CSA  
B125.1

California Energy  
Commission  
(CEC)

NSF/ANSI 372

NSF/ANSI/CAN  
61



## Wall-mounted basin spout without pop-up waste - Chrome

---

TARA

13 800 882

### Certificates

---

IAPMO\_N-4976. IAPMO\_4976 (4). IAPMO\_6397.

13 800 882

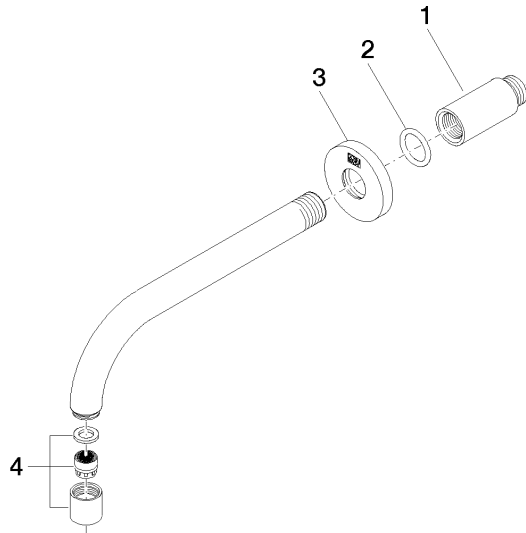

### Spare parts list

No.	Item Number	Name	Quantity used	Delivery time
1	09 24 03 081 10 90	extension	1	2
2	90 14 10 026 00 90	seal	1	2
3	09 27 22 503-00	rosette	1	10
4	90 23 01 019 02-00	aerator	1	10