





CYO Bath spout for wall mounting - Chrome

CYO

13 801 811



- 190mm projection
- rectangular, air-enriched flow
- hole diameter 37 mm
- 1/2" connection
- max. flow 23.8 l/min at 3 bar flow pressure

	Chrome	13 801 811-00
	Brushed Platinum	13 801 811-06
	Dark Chrome	13 801 811-19
	Brushed Durabronze (23kt Gold)	13 801 811-28
	Brushed Dark Platinum	13 801 811-99

Required miscellaneous

Concealed adapter -

35 080 970-90
0010



13 801 811

mm [inches]

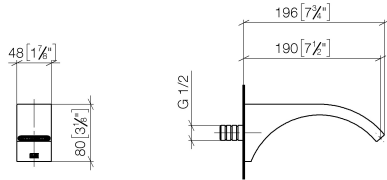

Flow rate chart



Certificates

IAPMO_4976 (6). LGA_38117.

13 801 811

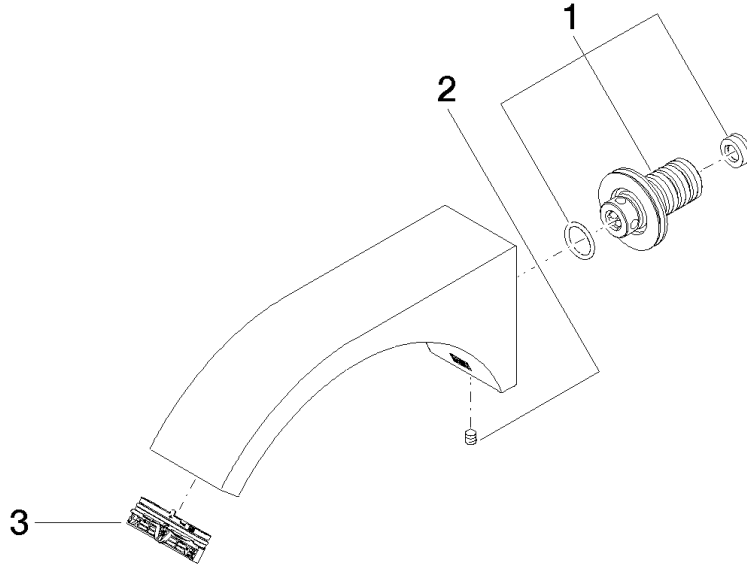

Spare parts list

No.	Item Number	Name	Quantity used	Delivery time
1	90 24 03 108 02 90	nipple set	1	2
2	90 31 11 004 00 90	pin	1	2
3	90 29 03 121 00 90	aerator	1	2