











19 825 809



- 241mm projection
- pivotable spout 360°
- air-enriched flow
- max. flow 5.7 l/min at 3 bar flow pressure
- lead-free
- This product can help a building meet the requirements of Green Building Rating Systems, e.g. LEED®, BREEAM®, DGNB

	Platinum	19 825 809-08 0010
	Chrome	19 825 809-00 0010
	Brushed Platinum	19 825 809-06 0010
	Durabronze (23kt Gold)	19 825 809-09 0010
	Dark Chrome	19 825 809-19 0010
	Brushed Durabronze (23kt Gold)	19 825 809-28 0010
	Matte Black	19 825 809-33 0010
	Brushed Champagne (22kt Gold)	19 825 809-46 0010
	Champagne (22kt Gold)	19 825 809-47 0010
	Brushed Chrome	19 825 809-93 0010
	Brushed Dark Platinum	19 825 809-99 0010

Recommended miscellaneous

VAIA Dispenser with rosette - Platinum 82 434 809-08



Recommended miscellaneous

VAIA AIR SWITCH Control button - Platinum 10 713 809-08



19 825 809

mm [inches]

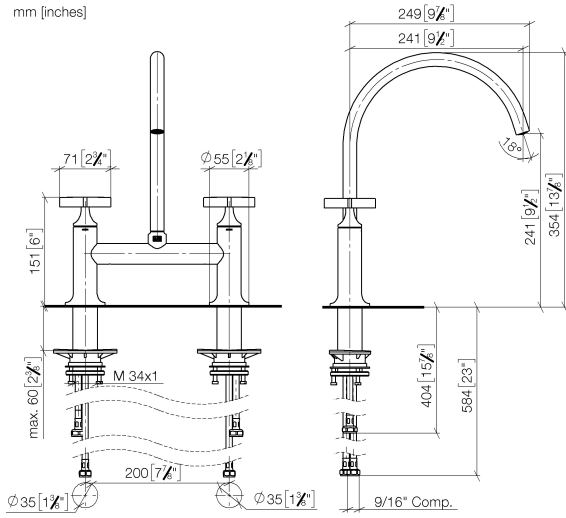

Flow rate chart

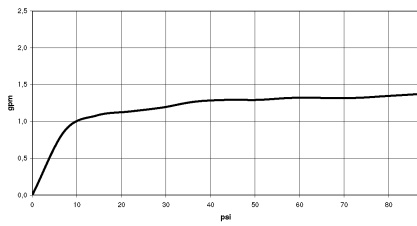

Codes & Standards

California Energy
Commission
(CEC)

19 825 809

Parts for other finishes can be found here: [Chrome](#)

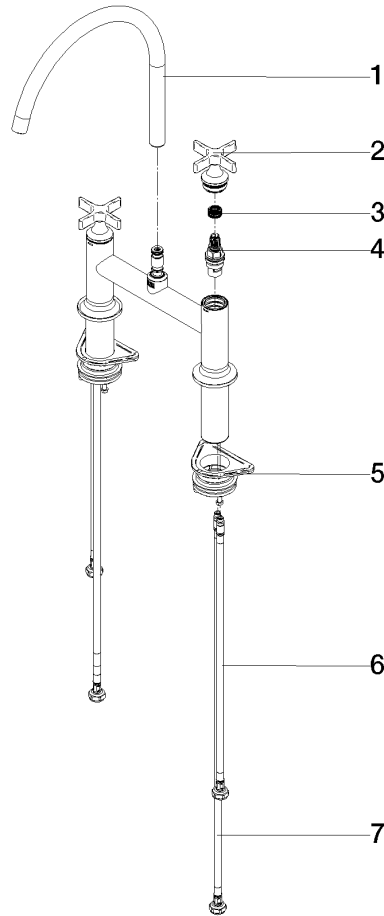

Spare parts list

No.	Item Number	Name	Quantity used	Delivery time
1	90 28 22 396 01-08	spout	1	-
Spare part can no longer be ordered, please order the replacement item				
2	90 20 80 036 00-08	handle	2	-
Spare part can no longer be ordered, please order the replacement item				
3	90 12 12 232 00 90	fixing cap	2	2
4	90 90 03 131 00 90	top	2	2
5	04 30 11 040 00 90	fixing set	2	2
6	04 30 04 100 00 90	hose	2	2
7	04 30 04 103 00 90	hose	2	2