











19 870 809



- 240mm projection
- pivotable spout 360°
- Optional swivel limiter available with swivel limiter set 12 823 970 90
- air-enriched flow and spray flow
- height of mixer 393 mm
- height up to laminar flow regulator 204 mm
- hole diameter 35 mm
- 2 x pressure hose with 3/8" cap nut
- 1800 mm metal shower hose
- sprayface with anti-scaling system
- max. flow 5.7 l/min at 3 bar flow pressure
- lead-free
- This product can help a building meet the requirements of Green Building Rating Systems, e.g. LEED®, BREEAM®, DGNB

Intrinsic protection against back flow.

Switch back and forth between aerator and spray mode while water is running.

	Chrome	19 870 809-00 0010
	Brushed Platinum	19 870 809-06 0010
	Platinum	19 870 809-08 0010
	Durabrace (23kt Gold)	19 870 809-09 0010
	Dark Chrome	19 870 809-19 0010
	Brushed Durabrace (23kt Gold)	19 870 809-28 0010
	Matte Black	19 870 809-33 0010
	Brushed Champagne (22kt Gold)	19 870 809-46 0010
	Champagne (22kt Gold)	19 870 809-47 0010
	Brushed Chrome	19 870 809-93 0010
	Brushed Dark Platinum	19 870 809-99 0010

Recommended miscellaneous

Swivel limitation set -

12 823 970 90



Recommended miscellaneous

VAIA Dispenser with rosette -
Chrome

82 434 809-00



Recommended miscellaneous

VAIA AIR SWITCH Control button - 10 713 809-00
Chrome



19 870 809

mm [inches]
1:5

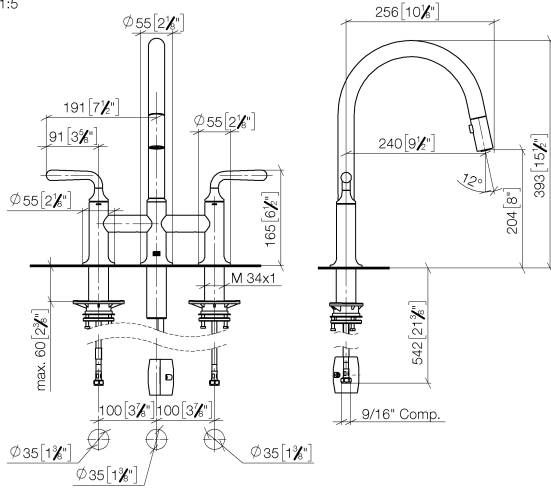

Flow rate chart

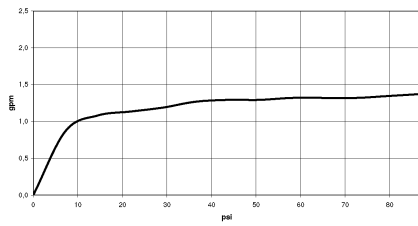

Codes & Standards

California Energy
Commission
(CEC)

19 870 809



Spare parts list

No.	Item Number	Name	Quantity used	Delivery time
1	90 28 22 397 00-00	spout	1	10
2	90 20 80 057 00-00	handle	2	10
3	90 12 12 232 00 90	fixing cap	2	2
4	90 90 03 130 00 90	top	1	2
5	04 30 11 040 00 90	fixing set	2	2
6	04 30 04 103 00 90	hose	2	2
7	04 21 50 010 00 90	accessories	1	2
8	04 30 02 120 00-00	hose	1	10
9	90 24 03 253 00 90	adaptor	1	2
10	04 28 20 067 00 90	pipe	1	2
11	90 90 03 131 00 90	top	1	2
12	90 18 40 317 00-00	shower	1	10