

Deck valve clockwise closing hot - Chrome







CL.1

20 000 715

- hole diameter 32 mm
- rosette 60 x 60 mm
- with hot marking



Fits: CL.1, CYO

| | | |
|---|-----------------------------------|---------------|
|  | Chrome | 20 000 715-00 |
|  | Brushed Platinum | 20 000 715-06 |
|  | Dark Chrome | 20 000 715-19 |
|  | Brushed Durabronze (23kt Gold) | 20 000 715-28 |
|  | Brushed Champagne (22kt Gold) | 20 000 715-46 |
|  | Champagne (22kt Gold) | 20 000 715-47 |
|  | Brushed Dark Platinum | 20 000 715-99 |



Deck valve clockwise closing hot - Chrome

CL.1

20 000 715

Certificates

IAPMO_4976 (5). LGA_28688.

20 000 715

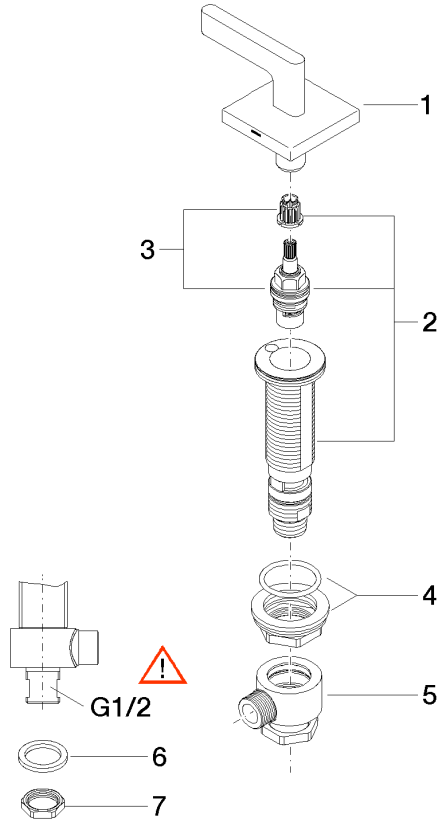

Spare parts list

| No. | Item Number | Name | Quantity used | Delivery time |
|-----|--------------------|----------------|---------------|---------------|
| 1 | 90 20 70 057 00-00 | handle (hot) | 1 | 10 |
| 2 | 04 17 11 058 33 90 | side panel | 1 | 2 |
| 3 | 90 90 03 133 00 90 | top | 1 | 2 |
| 4 | 04 23 10 032 78 90 | fixing set | 1 | 2 |
| 5 | 04 17 11 023 10 90 | distributor | 1 | 2 |
| 6 | 09 30 11 059 90 | disc | 1 | 2 |
| 7 | 09 23 10 012 90 | nut | 1 | 2 |