







20 006 705

- with CASCADE structure
- hole diameter 32 mm
- rosette 60 x 47 mm
- with cold marking



|   |                               |               |
|---|-------------------------------|---------------|
|  | Chrome                        | 20 006 705-00 |
|  | Brushed Platinum              | 20 006 705-06 |
|  | Dark Chrome                   | 20 006 705-19 |
|  | Brushed Champagne (22kt Gold) | 20 006 705-46 |
|  | Champagne (22kt Gold)         | 20 006 705-47 |
|  | Brushed Dark Platinum         | 20 006 705-99 |

20 006 705

mm [inches]

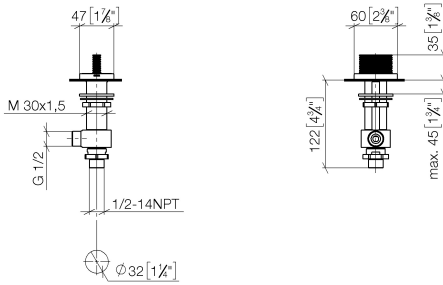

Flow rate chart



Codes & Standards

ADA

ASME  
A112.18.1/CSA  
B125.1

NSF/ANSI 372

NSF/ANSI/CAN  
61



CL.1 Deck valve clockwise closing cold - Chrome

CL.1

20 006 705

Certificates

WRAS\_1804020. IAPMO\_4976 (5). IAPMO\_N-4976. LGA\_28687. IAPMO\_6397.

WRAS\_240202020.

20 006 705

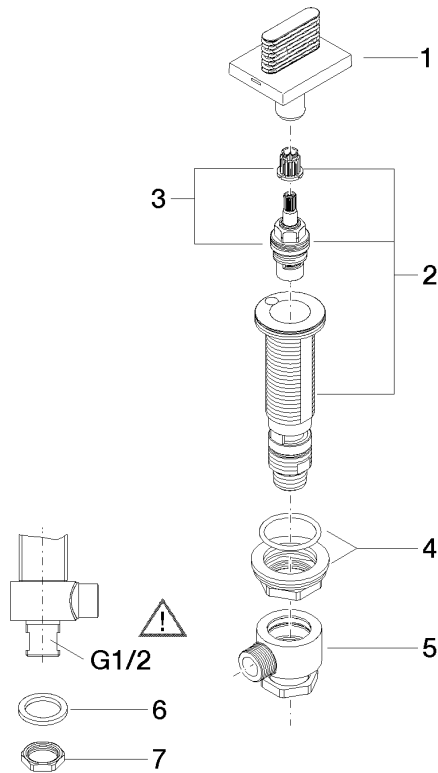

### Spare parts list

| No. | Item Number        | Name               | Quantity used | Delivery time |
|-----|--------------------|--------------------|---------------|---------------|
| 1   | 90 20 70 053 06-00 | handle ( cold )    | 1             | 10            |
| 2   | 04 17 11 058 53 90 | side panel         | 1             | 2             |
| 3   | 90 90 03 153 00 90 | top                | 1             | 2             |
| 4   | 04 23 10 032 78 90 | fixing set         | 1             | 2             |
| 5   | 04 17 11 023 10 90 | distributor        | 1             | 2             |
| 6   | 90 23 30 040 00-00 | threaded connector | 1             | 10            |
| 7   | 09 30 11 059 90    | disc               | 1             | 2             |
| 8   | 09 23 10 012 90    | nut                | 1             | 2             |