







20 700 360



- 135mm projection
- 1 1/4" pop-up waste
- fixed spout
- circular, air-enriched flow
- height of mixer 72 mm
- height up to aerator 40 mm
- hole diameter valve 32 mm
- hole diameter spout 35 mm
- without rosette
- 2x 1/2" x 1/2" high pressure hose
- max. flow 4.5 l/min
- lead-free
- This product can help a building meet the requirements of Green Building Rating Systems, e.g. LEED®, BREEAM®, DGNB

Only suitable for basins with an overflow.

	Brushed Dark Platinum	20 700 360-99 0010
	Chrome	20 700 360-00 0010
	Brushed Platinum	20 700 360-06 0010
	Platinum	20 700 360-08 0010
	Durabass (23kt Gold)	20 700 360-09 0010
	Brushed Durabass (23kt Gold)	20 700 360-28 0010

20 700 360

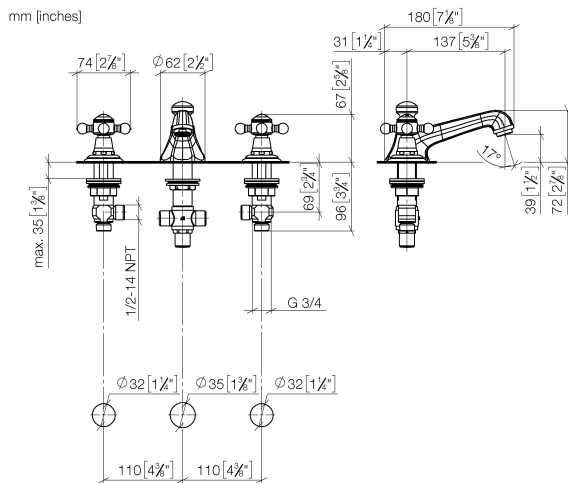

Flow rate chart

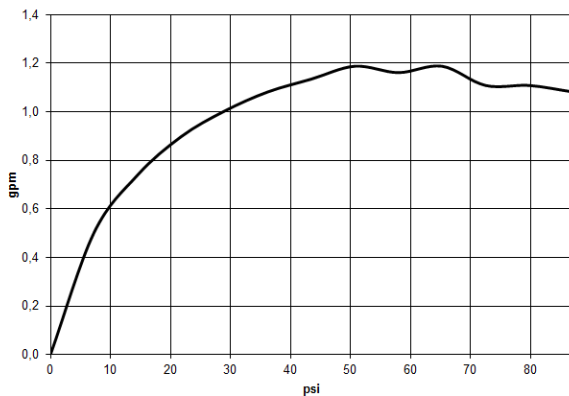

Codes & Standards

ADA

ASME
A112.18.1/CSA
B125.1

California Energy
Commission
(CEC)

NSF/ANSI 372

NSF/ANSI/CAN
61



MADISON Three-hole basin mixer with pop-up waste - Brushed Dark Platinum

MADISON

20 700 360

Certificates

IAPMO_N-4976. IAPMO_4976 (4). IAPMO_6397.

20 700 360

Parts for other finishes can be found here: [Chrome](#)

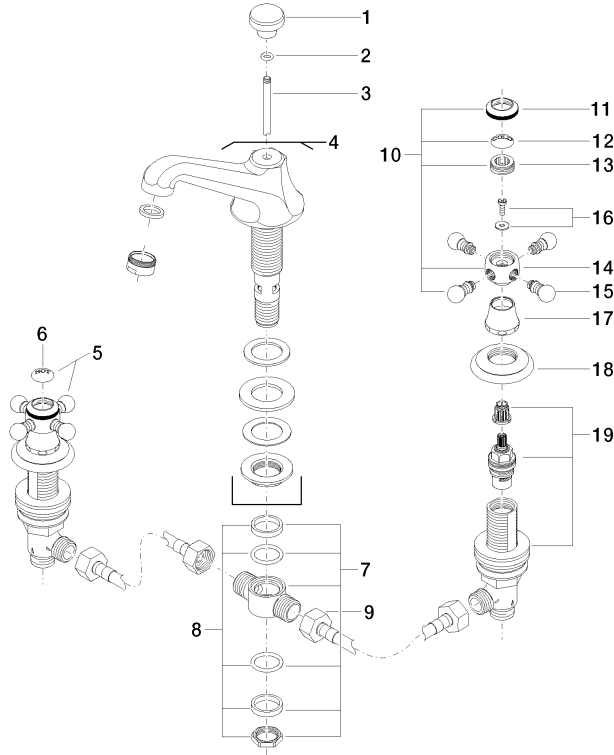

20 ————— Ablaufgarnitur 04.11.01.001.00.FP

Spare parts list

No.	Item Number	Name	Quantity used	Delivery time
1	09 20 36 030-99	handle	1	30
2	90 14 10 062 00 90	seal	1	2
3	09 31 09 004-99	pull-rod	1	30
4	13 700 380-99 0010	spout	1	30
5	04 20 36 002 07-99	handle (hot)	1	30
6	09 26 01 011 90	accessories	1	2
7	90 17 11 020 10 90	distributor	1	2
8	90 23 10 012 00 90	gasket kit	1	2
9	04 30 04 096 00 90	hose	2	2
10	04 20 36 002 06-99	handle (cold)	1	30
11	09 20 36 005-99	handle	2	30
12	09 26 01 010 90	accessories	1	2
13	09 20 83 006 90	handle	2	2
14	09 20 36 002-99	handle	2	30
15	09 20 36 004-99	handle	8	30
16	04 30 30 029 00 90	fixing set	2	2
17	09 21 02 055-99	cover	2	30
18	09 27 35 001-99	rosette	2	30
19	90 17 11 040 51 90	side panel	2	2
20	90 11 01 023 00-99	pop-up waste	1	30