











TARA Single-hole basin mixer with pop-up waste - Brushed Durabronz (23kt Gold)

TARA

22 513 892



- 165mm projection
- 1 1/4" pop-up waste
- pivotable spout 360°
- circular, air-enriched flow
- height of mixer 295 mm
- height up to aerator 172 mm
- hole diameter 35 mm
- rosette Ø 59 mm
- 2 x pressure hose with 3/8" cap nut
- max. flow 4.5 l/min
- lead-free
- This product can help a building meet the requirements of Green Building Rating Systems, e.g. LEED®, BREEAM®, DGNB

	Brushed Durabronz (23kt Gold)	22 513 892-28 0010
	Chrome	22 513 892-00 0010
	Brushed Platinum	22 513 892-06 0010
	Platinum	22 513 892-08 0010
	Dark Chrome	22 513 892-19 0010
	Matte Black	22 513 892-33 0010
	Brushed Champagne (22kt Gold)	22 513 892-46 0010
	Champagne (22kt Gold)	22 513 892-47 0010
	Brushed Chrome	22 513 892-93 0010
	Brushed Dark Platinum	22 513 892-99 0010



TARA Single-hole basin mixer with pop-up waste - Brushed Durabross (23kt Gold)

TARA

22 513 892

mm [inches]

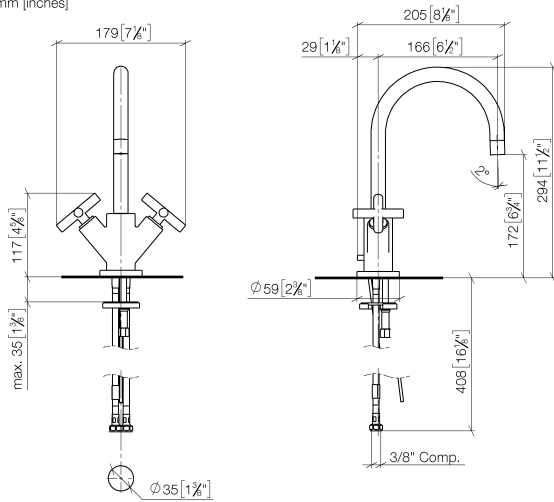

Flow rate chart

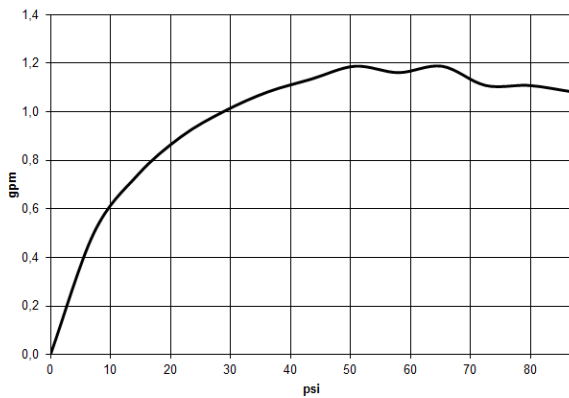

Codes & Standards

ADA

ASME
A112.18.1/CSA
B125.1

California Energy
Commission
(CEC)

NSF/ANSI 372

NSF/ANSI/CAN
61



TARA Single-hole basin mixer with pop-up waste - Brushed Durabronz (23kt Gold)

TARA

22 513 892

Certificates

IAPMO_N-4976.

IAPMO_6397.

22 513 892
Parts for other finishes can be found here: [Chrome](#)

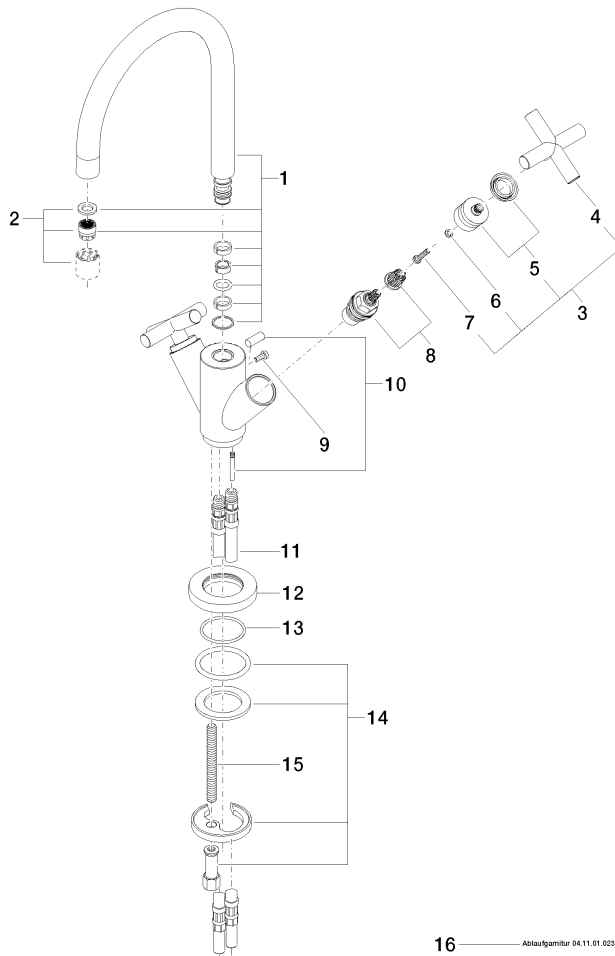

Spare parts list

No.	Item Number	Name	Quantity used	Delivery time
1	90 28 22 213 02-28	spout	1	20
2	90 23 01 028 04-28	aerator	1	20
3	90 20 89 010 10-28	handle	2	20
4	09 20 89 010-28	handle	2	60
5	90 12 12 007 00-28	base	2	20
6	90 30 11 029 00 90	disc	2	2
7	90 30 30 075 00 90	screw	2	2
8	90 90 03 151 00 90	top	2	2
9	09 30 30 054 90	screw	1	2
10	04 20 89 035 80-28	pull-rod	1	20
11	04 30 04 045 00 90	hose	2	60
12	09 28 10 132-28	ring	1	20
13	09 14 10 134 90	seal	1	2
14	04 30 11 038 00 90	fixing set	1	2
15	09 31 11 011 90	pin	1	2
16	90 11 01 023 00-28	pop-up waste	1	20