











META Single-lever basin mixer with stand pipe without pop-up waste - Light Gold

META

22 584 661



- 202mm projection
- circular, air-enriched flow
- total height 1197 - 1267 mm
- height up to water outlet point 1098 mm
- rosette Ø 135 mm
- max. flow 4.5 l/min
- lead-free
- This product can help a building meet the requirements of Green Building Rating Systems, e.g. LEED®, BREEAM®, DGNB
- pivoting spout

	Light Gold	22 584 661-26 0010
	Chrome	22 584 661-00 0010
	Brushed Platinum	22 584 661-06 0010
	Brushed Light Gold	22 584 661-27 0010
	Matte Black	22 584 661-33 0010
	Brushed Bronze	22 584 661-42 0010
	Brushed Champagne (22kt Gold)	22 584 661-46 0010
	Champagne (22kt Gold)	22 584 661-47 0010
	Brushed Chrome	22 584 661-93 0010
	Brushed Dark Platinum	22 584 661-99 0010

Required miscellaneous



- Concealed floor mounting -**
- min. recess depth 80 mm
 - max. recess depth 150 mm

35 949 970-90
0010

22 584 661
mm [inches]

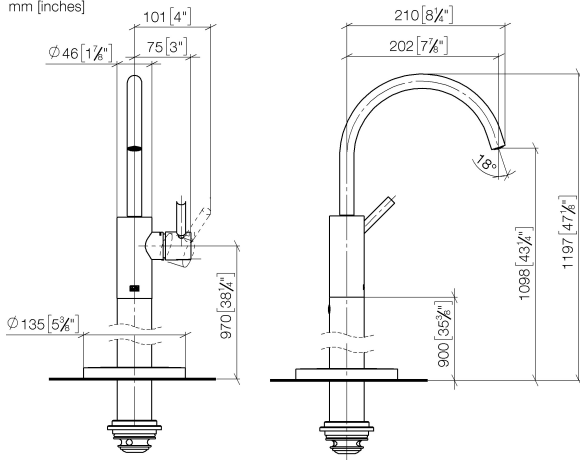

Flow rate chart

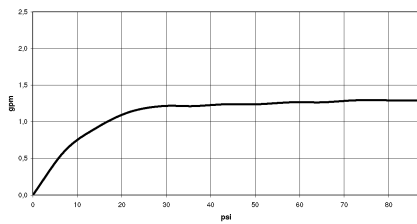

Codes & Standards

California Energy
Commission
(CEC)

22 584 661



Spare parts list

No.	Item Number	Name	Quantity used	Delivery time
1	90 28 22 313 01-26	spout	1	30
2	90 15 05 042 00 90	cartridge	1	2
3	09 24 04 266 90	nut	1	2
4	09 14 10 091 90	seal	1	2
5	09 28 30 021-26	cover	1	60
6	90 20 66 003 00-26	handle	1	30
7	09 30 30 111 90	screw	1	2
8	09 14 10 139 90	seal	2	2
9	04 28 22 022 10 90	connection	2	2
10	04 31 11 002 00 90	pin	1	2
11	90 28 22 574 00-26	pipe	1	30
12	09 27 88 005-26	rosette	1	60
13	09 14 10 084 90	seal	2	2
14	09 14 10 018 90	seal	1	2