







27 532 782



- 220mm projection
- spout: rectangular normal flow
- max. flow 27.3 l/min at 3 bar flow pressure
- Hand shower: COMPACT RAIN, max. flow rate 6.8 l/min (at 3 bar)
- complete hand shower set with anti-scale system
- automatic bath/shower diverter
- height of mixer 300 mm
- height up to aerator 170 mm
- hole diameter valve 32 mm
- hole diameter spout 32 mm
- hole diameter for complete hand shower set 32 mm
- rosette for spout 60 x 60mm
- rosette for complete hand shower set 60 x 60mm
- rosette for deck valve 60 x 60mm
- metal shower hose 1750mm with integrated anti-twist protection
- WRAS 1711017

Intrinsic protection against back flow.

Note: Local building codes may require the use of an anti-scald device. Please refer to remote pressure balance valve (35 910 970 90)

	Chrome	27 532 782-00
	Brushed Platinum	27 532 782-06
	Platinum	27 532 782-08
	Dark Chrome	27 532 782-19
	Brushed Durabronze (23kt Gold)	27 532 782-28
	Brushed Dark Platinum	27 532 782-99



MEM Bath shower set for bath rim or tile edge installation - Chrome

MEM

27 532 782

Certificates

IAPMO_4976 (5). WRAS_2306058. LGA_9681. Belgaqua_21-026-27_4.

27 532 782

Parts for other finishes can be found here: Brushed Platinum

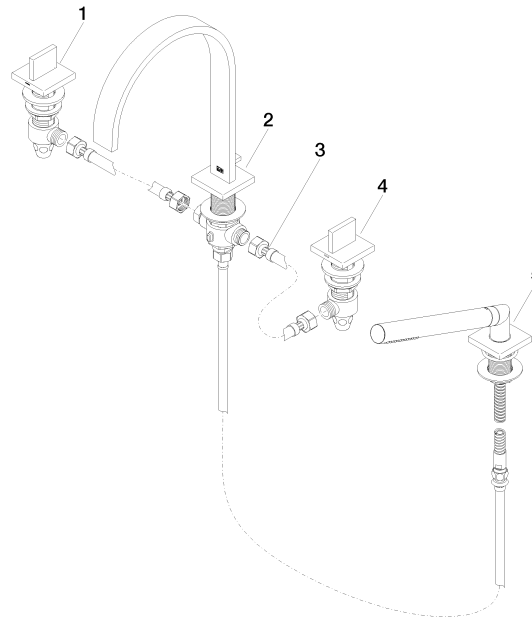

Spare parts list

No.	Item Number	Name	Quantity used	Delivery time
1	20 000 783-00	MEM Deck valve anti-clockwise closing hot - Chrome	1	10
2	13 512 782-00	spout	1	60
3	12 502 970 90	High pressure hose 1/2" x 1/2" x 400 mm -	1	2
4	20 000 782-00	MEM Deck valve clockwise closing cold - Chrome	1	10
5	27 702 980-00	Hand shower set for bath rim or tile edge installation - Chrome	1	10