

27 718 809



- with round rosette
- spray flow
- automatic spout/shower diverter
- height of mixer 171 mm
- hole diameter rinsing spray 32mm
- fabric braided hose 1500 mm
- sprayface with anti-scaling system
- lead-free
- This product can help a building meet the requirements of Green Building Rating Systems, e.g. LEED®, BREEAM®, DGNB







Can only be combined with 33810809, 33826809, 19815809, 19825809.

Intrinsic protection against back flow.

Residual water may emerge from the spray after closing.

Operating unit can be positioned freely.

Button has to be pressed while using.

	Brushed Chrome	27 718 809-93
	Chrome	27 718 809-00
	Brushed Platinum	27 718 809-06
	Platinum	27 718 809-08
	Durabrand (23kt Gold)	27 718 809-09
	Dark Chrome	27 718 809-19
	Brushed Durabrand (23kt Gold)	27 718 809-28
	Matte Black	27 718 809-33
	Brushed Champagne (22kt Gold)	27 718 809-46
	Champagne (22kt Gold)	27 718 809-47
	Brushed Dark Platinum	27 718 809-99

27 718 809

mm [inches]

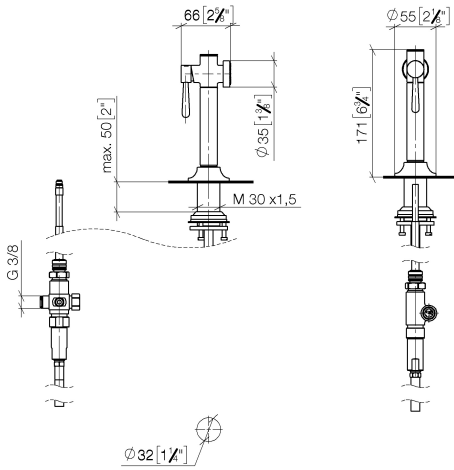

Flow rate chart



Certificates

LGA\_38634.

27 718 809

Parts for other finishes can be found here: [Chrome](#)

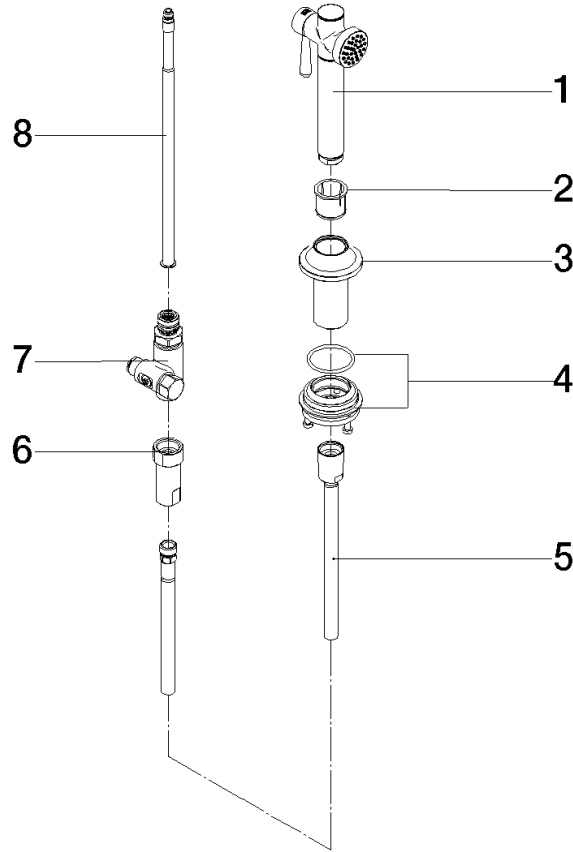

Spare parts list

No.	Item Number	Name	Quantity used	Delivery time
1	90 12 11 096 12-93	shower	1	-
Spare part can no longer be ordered, please order the replacement item				
2	90 18 40 085 00 90	sleeve	1	2
3	90 30 01 142 00-93	shaft	1	-
Spare part can no longer be ordered, please order the replacement item				
4	04 23 10 047 00 92	fixing set	1	60
5	90 30 02 062 00-93	hose	1	20
6	90 24 03 241 00 90	nipple	1	2
7	90 17 09 046 12 90	diverter	1	2
8	90 28 20 068 00 90	connection	1	2