

Hand shower set with integrated shower holder FlowReduce - Brushed Dark Platinum

TARA













27 802 660



Fits: TARA, VAIA, META

- COMPACT RAIN, max. flow rate 6.8 l/min (at 3 bar)
- with anti-scale system
- 3/8" shower outlet
- metal shower hose 1250mm with integrated anti-twist protection
- rosette Ø 60 mm
- 1/2" connection
- This product reduces water consumption by % (compared to requirements of EAct '92)
- This product can contribute to Water Use Reduction in LEED® Green Building Rating
- This product can help a building meet the requirements of Green Building Rating Systems, e.g. LEED®, BREEAM®, DGNB

Intrinsic protection against back flow.

	Brushed Dark Platinum	27 802 660-99 0010
	Chrome	27 802 660-00 0010
	Brushed Platinum	27 802 660-06 0010
	Platinum	27 802 660-08 0010
	Dark Chrome	27 802 660-19 0010
	Light Gold	27 802 660-26 0010
	Brushed Light Gold	27 802 660-27 0010
	Brushed Durabronze (23kt Gold)	27 802 660-28 0010
	Matte Black	27 802 660-33 0010
	Brushed Bronze	27 802 660-42 0010
	Brushed Champagne (22kt Gold)	27 802 660-46 0010
	Champagne (22kt Gold)	27 802 660-47 0010
	Brushed Chrome	27 802 660-93 0010

Recommended miscellaneous

Concealed adapter -

35 080 970-90
0010



27 802 660
mm [inches]

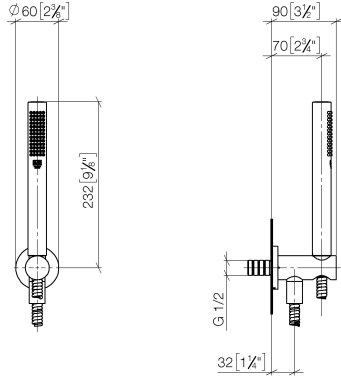

Flow rate chart

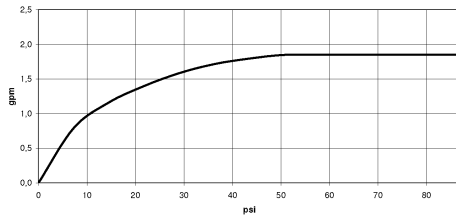

Codes & Standards

ASME
A112.18.1/CSA
B125.1

California Energy
Commission
(CEC)



Hand shower set with integrated shower holder FlowReduce - Brushed Dark
Platinum

TARA

27 802 660

Certificates

LGA_29985.

27 802 660

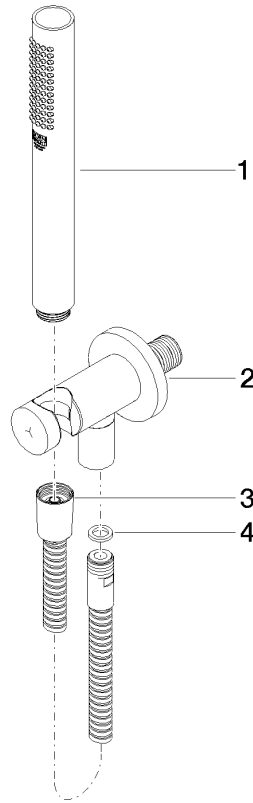

Spare parts list

No.	Item Number	Name	Quantity used	Delivery time
1	90 12 11 140 30-99	shower	1	30
2	28 490 660-99	Wall elbow with integrated shower holder - Brushed Dark Platinum	1	30
3	90 30 02 072 00-99	Metal shower hose 1/2" x 3/8" x 1250 mm - Brushed Dark Platinum	1	30
4	90 14 20 026 00 90	seal	1	2