







27 803 660



Fits: TARA, VAIA, META

- COMPACT RAIN, max. flow rate 6.8 l/min (at 3 bar)
- three settings: normal flow, soft flow, massage flow
- with anti-scale system
- 3/8" shower outlet
- metal shower hose 1250mm with integrated anti-twist protection
- rosette Ø 60 mm
- 1/2" connection
- Function from: 6 l/min
- This product reduces water consumption by % (compared to requirements of EPAAct '92)
- This product can contribute to Water Use Reduction in LEED® Green Building Rating
- This product can help a building meet the requirements of Green Building Rating Systems, e.g. LEED®, BREEAM®, DGNB

Intrinsic protection against back flow.

	Chrome	27 803 660-00 0010
	Brushed Platinum	27 803 660-06 0010
	Platinum	27 803 660-08 0010
	Dark Chrome	27 803 660-19 0010
	Light Gold	27 803 660-26 0010
	Brushed Light Gold	27 803 660-27 0010
	Brushed Durabrass (23kt Gold)	27 803 660-28 0010
	Matte Black	27 803 660-33 0010
	Brushed Bronze	27 803 660-42 0010
	Brushed Champagne (22kt Gold)	27 803 660-46 0010
	Champagne (22kt Gold)	27 803 660-47 0010
	Brushed Chrome	27 803 660-93 0010
	Brushed Dark Platinum	27 803 660-99 0010

Recommended miscellaneous

Concealed adapter -

35 080 970-90  
0010



27 803 660

mm [inches]

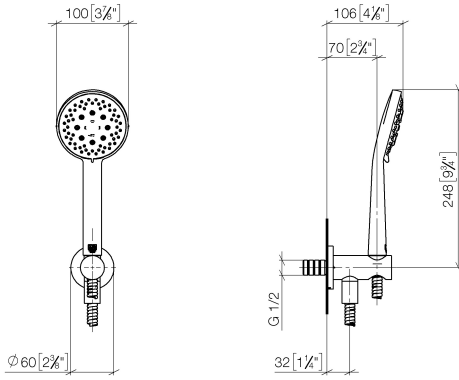

Flow rate chart

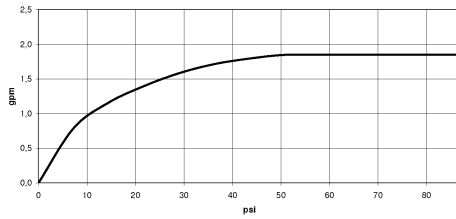

Codes & Standards

ASME  
A112.18.1/CSA  
B125.1

California Energy  
Commission  
(CEC)



## Hand shower set with integrated shower holder FlowReduce - Chrome

---

TARA

27 803 660

### Certificates

---

LGA\_29984.

27 803 660

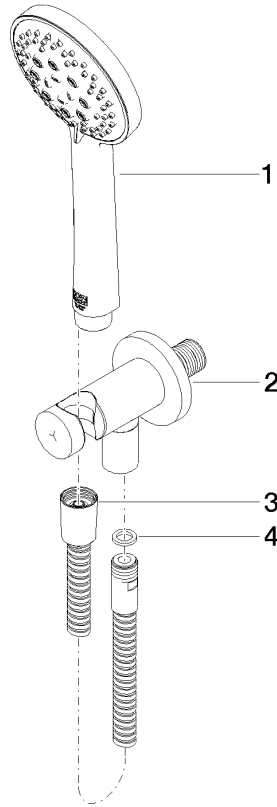

**Spare parts list**

No.	Item Number	Name	Quantity used	Delivery time
1	28 014 979-00 0010	Hand shower - Chrome	1	-
Spare part can no longer be ordered, please order the replacement item				
	28018979-000010	Hand shower FlowReduce - Chrome		
2	28 490 660-00	Wall elbow with integrated shower holder - Chrome	1	10
3	90 30 02 072 00-00	Metal shower hose 1/2" x 3/8" x 1250 mm - Chrome	1	10
4	90 14 20 026 00 90	seal	1	2