

**Rain shower for surface-mounted ceiling installation with light 300 mm -
Brushed Platinum**

TARA

28 032 970



Fits: TARA, LISSÉ, VAIA, META













- rain shower Ø 300 mm
- PURE RAIN, max. flow rate 6.8 l/min (at 3 bar)
- PURIFY RAIN, max. flow rate 6 l/min (at 3 bar)
- Distance to ceiling from bottom edge of shower 40 mm
- with anti-scale system
- central LED Spot 3000 K
- Provided by customer: Light switch
- This product can help a building meet the requirements of Green Building Rating Systems, e.g. LEED®, BREEAM®, DGNB
- Not suitable for use in a steam room.

Three-way diverter trim is sold separately

Pre-assembly kit for three-way diverter included includes light bulbs with a Class F energy efficiency

Three-way diverter trim is sold separately

Pre-assembly kit for three-way diverter included includes light bulbs with a Class F energy efficiency

	Brushed Platinum	28 032 970-06 0010
	Chrome	28 032 970-00 0010
	Platinum	28 032 970-08 0010
	Dark Chrome	28 032 970-19 0010
	Light Gold	28 032 970-26 0010
	Brushed Light Gold	28 032 970-27 0010
	Brushed Durabrass (23kt Gold)	28 032 970-28 0010
	Matte Black	28 032 970-33 0010
	Brushed Bronze	28 032 970-42 0010
	Brushed Champagne (22kt Gold)	28 032 970-46 0010
	Champagne (22kt Gold)	28 032 970-47 0010
	Brushed Chrome	28 032 970-93 0010
	Brushed Dark Platinum	28 032 970-99 0010

Required miscellaneous



Concealed ceiling installation box for surface-mounted ceiling installation with light - 35 042 970-90 0010

- max. recess depth 115 mm
- Provided by customer: Light switch
- min. recess depth 90 mm
- Pre-assembly kit for three-way diverter included



Rain shower for surface-mounted ceiling installation with light 300 mm - Brushed Platinum

TARA

28 032 970

mm [inches]

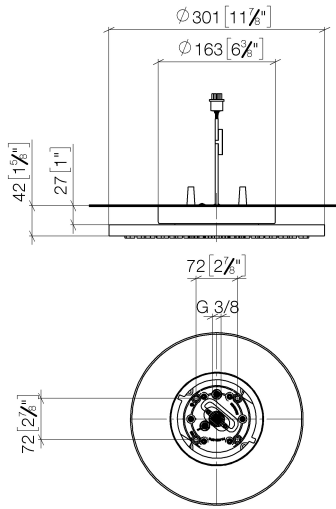

Flow rate chart

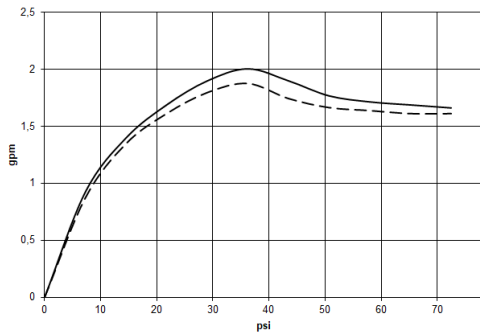

Codes & Standards

California Energy
Commission
(CEC)

Water Sense





Rain shower for surface-mounted ceiling installation with light 300 mm -
Brushed Platinum

TARA

28 032 970

Certificates

IAPMO_11777.

IAPMO_4976 (7).

28 032 970

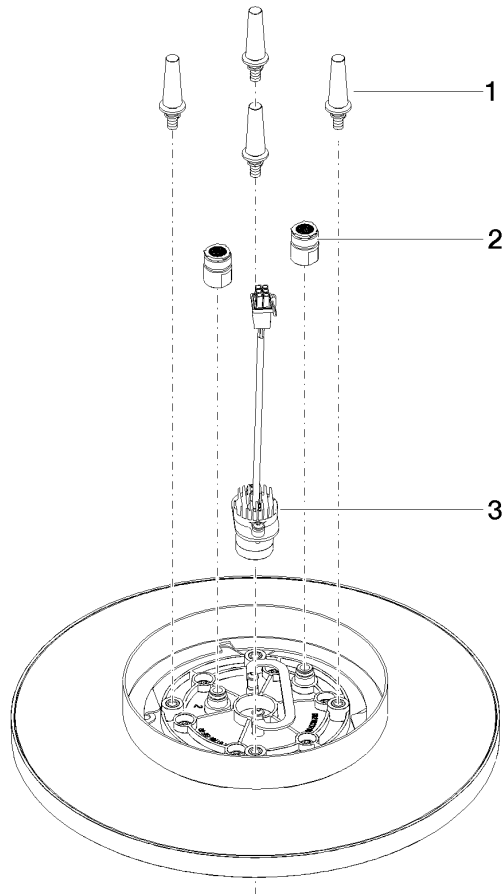

Spare parts list

No.	Item Number	Name	Quantity used	Delivery time
1	90 17 20 263 00 90	fixing set	1	2
2	90 24 03 309 02 90	connection	2	2
3	90 10 01 225 00 90	electronic accessories	1	2