

28 034 970

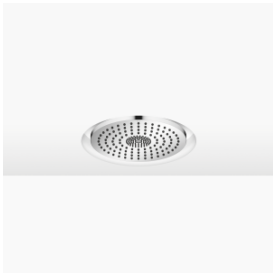

Fits: TARA, LISSÉ, VAIA, META

- rain shower Ø 300 mm
- PURE RAIN, max. flow rate 6.8 l/min (at 3 bar)
- PURIFY RAIN, max. flow rate 6 l/min (at 3 bar)
- min. recess depth 137 mm
- with anti-scale system
- central RGBW LED spot
- RGBW LED ambient lighting
- This product can help a building meet the requirements of Green Building Rating Systems, e.g. LEED®, BREEAM®, DGNB
- Provided by customer: Zigbee gateway
- Not suitable for use in a steam room.











**Three-way diverter trim is sold separately**

**Pre-assembly kit for three-way diverter included includes light bulbs with a Class G energy efficiency**

Three-way diverter trim is sold separately

Pre-assembly kit for three-way diverter included

includes light bulbs with a Class G energy efficiency

	Chrome	28 034 970-00 0010
	Brushed Platinum	28 034 970-06 0010
	Platinum	28 034 970-08 0010
	Dark Chrome	28 034 970-19 0010
	Light Gold	28 034 970-26 0010
	Brushed Light Gold	28 034 970-27 0010
	Brushed Durabronze (23kt Gold)	28 034 970-28 0010
	Matte Black	28 034 970-33 0010
	Brushed Bronze	28 034 970-42 0010
	Brushed Champagne (22kt Gold)	28 034 970-46 0010
	Champagne (22kt Gold)	28 034 970-47 0010
	Brushed Chrome	28 034 970-93 0010
	Brushed Dark Platinum	28 034 970-99 0010

### Required miscellaneous



**Concealed ceiling installation box for recessed ceiling installation with light -** 35 034 970-90 0010

- To be provided by the customer. Zigbee Gateway!
- recess depth 137mm
- Pre-assembly kit for three-way diverter included

28 034 970

mm [inches]

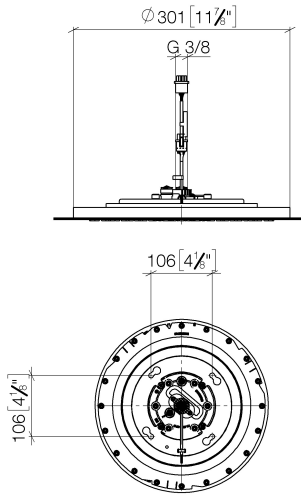

Flow rate chart

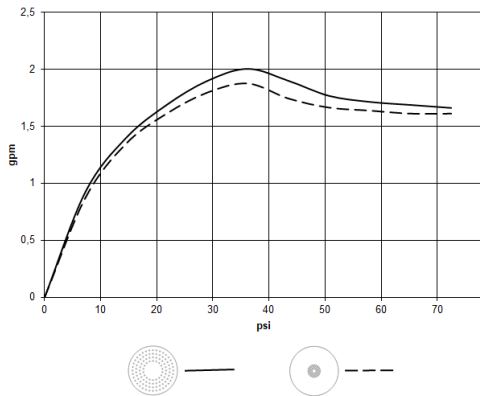

Codes & Standards

California Energy  
Commission  
(CEC)

Water Sense





## Rain shower for recessed ceiling installation with light 300 mm - Chrome

---

TARA

28 034 970

### Certificates

---

IAPMO\_11777.

IAPMO\_4976 (7).

28 034 970

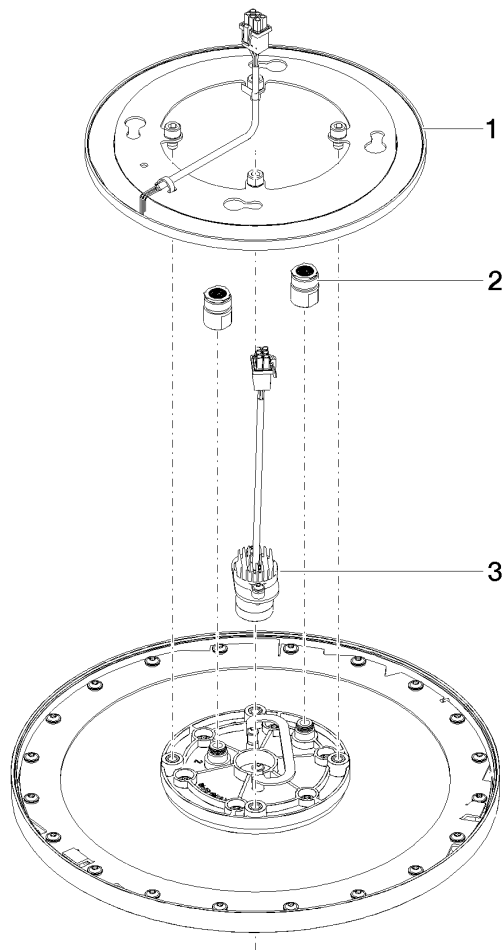

Spare parts list

No.	Item Number	Name	Quantity used	Delivery time
1	90 10 01 221 00 90	electronic accessories	1	2
2	90 24 03 309 02 90	connection	1	2
3	90 10 01 225 00 90	electronic accessories	1	2