













28 508 979



Fits: TARA, LISSÉ, VAIA, META

- 200mm projection
- ball-joint pivotable through 30°
- Three settings: PURIFY RAIN, COMPACT SOFT FLOW, COMPACT AQUAPRESSURE FLOW, max. flow rate 6.8 l/min (at 3 bar)
- with anti-scale system
- spray head Ø 92mm
- rosette Ø 55 mm
- 1/2" connection
- This product reduces water consumption by % (compared to requirements of EAct '92)
- This product can contribute to Water Use Reduction in LEED® Green Building Rating
- This product can help a building meet the requirements of Green Building Rating Systems, e.g. LEED®, BREEAM®, DGNB

	Chrome	28 508 979-00 0010
	Brushed Platinum	28 508 979-06 0010
	Platinum	28 508 979-08 0010
	Dark Chrome	28 508 979-19 0010
	Light Gold	28 508 979-26 0010
	Brushed Light Gold	28 508 979-27 0010
	Brushed Durabrass (23kt Gold)	28 508 979-28 0010
	Matte Black	28 508 979-33 0010
	Brushed Bronze	28 508 979-42 0010
	Brushed Champagne (22kt Gold)	28 508 979-46 0010
	Champagne (22kt Gold)	28 508 979-47 0010
	Brushed Chrome	28 508 979-93 0010
	Brushed Dark Platinum	28 508 979-99 0010



# Shower head FlowReduce - Chrome

TARA

28 508 979

mm [inches]

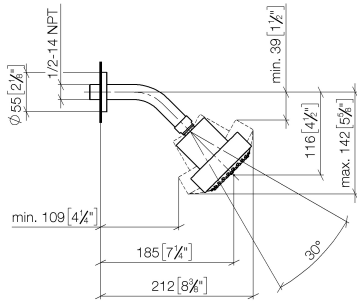

## Flow rate chart

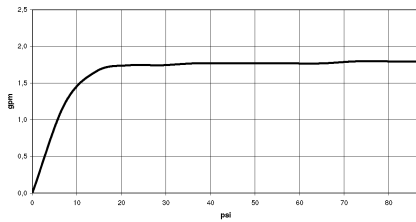

## Codes & Standards

ASME  
A112.18.1/CSA  
B125.1

California Energy  
Commission  
(CEC)

Water Sense





## Shower head FlowReduce - Chrome

---

TARA

28 508 979

### Certificates

---

IAPMO\_11777.      IAPMO\_4976 (3).      LGA\_38653.

28 508 979

Parts for other finishes can be found here: [Brushed Platinum](#)

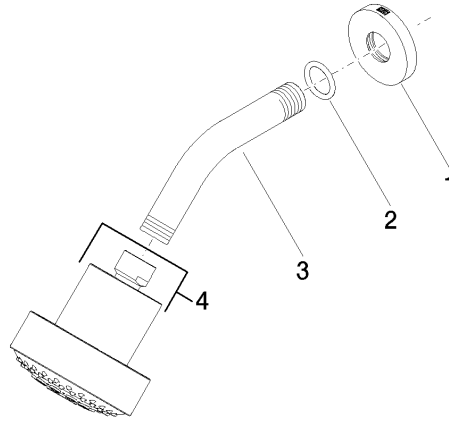

### Spare parts list

No.	Item Number	Name	Quantity used	Delivery time
1	09 27 22 019-00	rosette	1	10
2	90 14 10 026 00 90	seal	1	2
3	09 11 03 011-00	connection	1	10
4	04 12 11 110 30-00	shower	1	10