













28 679 970



Fits: TARA, LISSÉ, VAIA, META

- 450mm projection
- PURE RAIN, max. flow rate 6.8 l/min (at 3 bar)
- Function from: 6.5 l/min
- with anti-scale system
- rain shower Ø 300 mm
- rosette Ø 60 mm
- 1/2" connection
- quick clearing
- This product reduces water consumption by % (compared to requirements of EPAAct '92)
- This product can contribute to Water Use Reduction in LEED® Green Building Rating
- This product can help a building meet the requirements of Green Building Rating Systems, e.g. LEED®, BREEAM®, DGNB

| | | |
|---|--------------------------------|--------------------|
|  | Brushed Durabronze (23kt Gold) | 28 679 970-28 0010 |
|  | Chrome | 28 679 970-00 0010 |
|  | Brushed Platinum | 28 679 970-06 0010 |
|  | Platinum | 28 679 970-08 0010 |
|  | Dark Chrome | 28 679 970-19 0010 |
|  | Light Gold | 28 679 970-26 0010 |
|  | Brushed Light Gold | 28 679 970-27 0010 |
|  | Matte Black | 28 679 970-33 0010 |
|  | Brushed Bronze | 28 679 970-42 0010 |
|  | Brushed Champagne (22kt Gold) | 28 679 970-46 0010 |
|  | Champagne (22kt Gold) | 28 679 970-47 0010 |
|  | Brushed Chrome | 28 679 970-93 0010 |
|  | Brushed Dark Platinum | 28 679 970-99 0010 |

Required miscellaneous

| | | |
|---|--|-----------------------|
|  | Concealed wall elbow - •max. recess depth 163 mm •min. recess depth 90 mm | 35 085 970-90 0010 |
|---|--|-----------------------|

28 679 970

mm [inches]

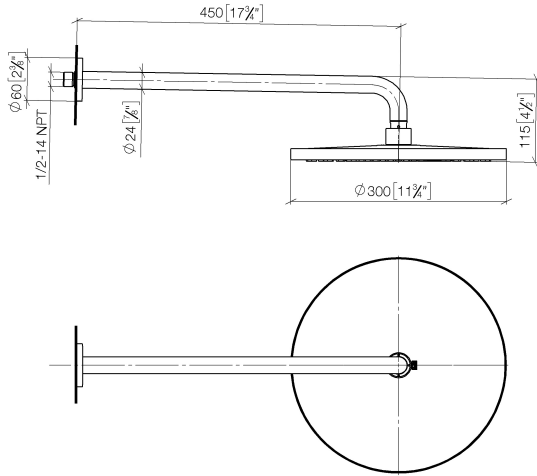

Flow rate chart



Codes & Standards

| | |
|---------------------------------|--|
| ASME A112.18.1/CSA B125.1 | California Energy Commission (CEC) |
|---------------------------------|--|

28 679 970

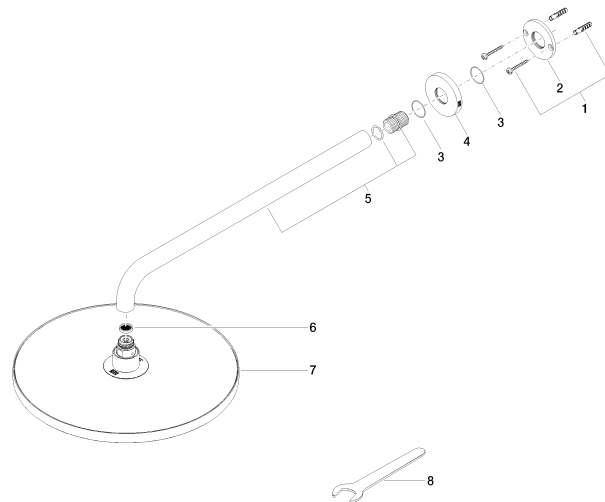

Spare parts list

| No. | Item Number | Name | Quantity used | Delivery time |
|-----|--------------------|------------|---------------|---------------|
| 1 | 04 30 31 032 00 90 | fixing set | 1 | 2 |
| 2 | 09 17 20 120 90 | holder | 1 | 2 |
| 3 | 09 14 10 150 90 | seal | 2 | 2 |
| 4 | 09 27 97 015-28 | rosette | 1 | 20 |
| 5 | 90 11 03 070 00-28 | pipe | 1 | 20 |
| 6 | 09 23 01 075 90 | insert | 1 | 2 |
| 7 | 04 12 05 091 10-28 | shower | 1 | 20 |
| 8 | 90 30 09 069 00 90 | key | 1 | 2 |