







29 140 892



- automatic bath/shower diverter
- hole diameter 32 mm
- rosette Ø 55 mm
- 1/2" connection
- max. flow 64.9 l/min at 3 bar flow pressure
- WRAS 1911025

	Chrome	29 140 892-00
	Brushed Platinum	29 140 892-06
	Platinum	29 140 892-08
	Dark Chrome	29 140 892-19
	Brushed Durabronze (23kt Gold)	29 140 892-28
	Matte Black	29 140 892-33
	Brushed Champagne (22kt Gold)	29 140 892-46
	Champagne (22kt Gold)	29 140 892-47
	Brushed Chrome	29 140 892-93
	Brushed Dark Platinum	29 140 892-99

29 140 892

mm [inches]

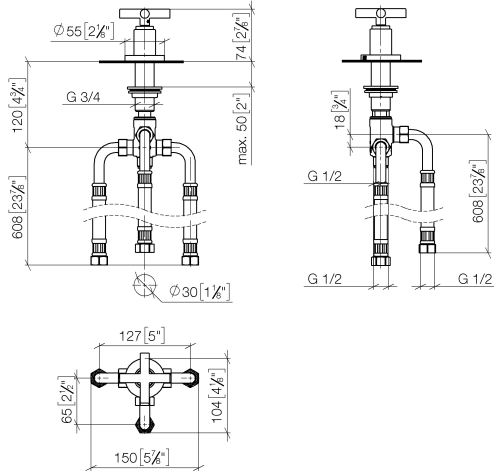

Flow rate chart

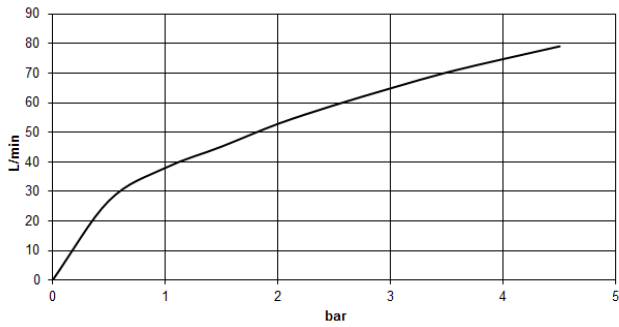

Codes & Standards

ASME  
A112.18.1/CSA  
B125.1

California Energy  
Commission  
(CEC)



## TARA Two-way diverter for bath rim or tile edge installation - Chrome

---

TARA

29 140 892

### Certificates

---

IAPMO\_4976 (5).    WRAS\_1911025.    LGA\_29990.

29 140 892

Parts for other finishes can be found here: [Brushed](#) [Platinum](#)

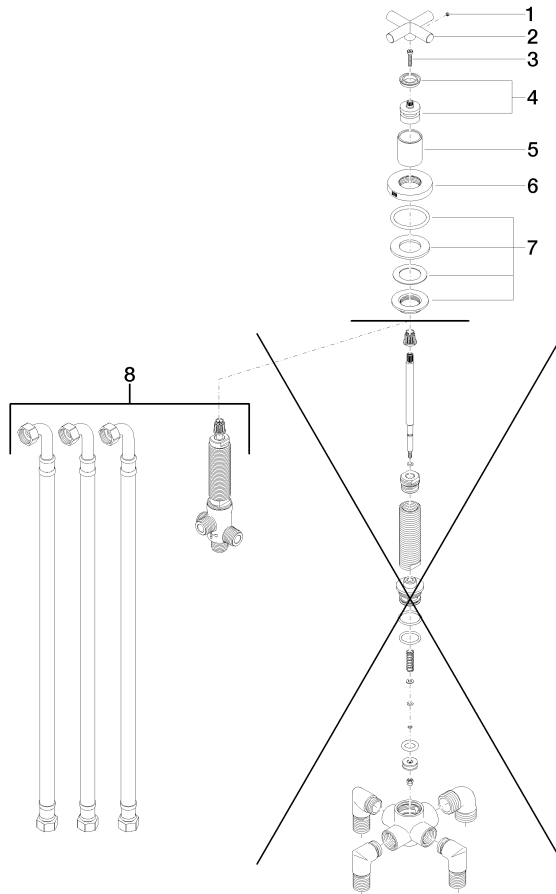

### Spare parts list

No.	Item Number	Name	Quantity used	Delivery time
1	09 31 11 055 90	pin	1	2
2	09 20 89 011-00	handle	1	10
3	90 30 30 075 00 90	screw	1	2
4	90 12 12 007 00-00	base	1	10
5	09 21 02 140-00	sleeve	1	10
6	09 27 89 102-00	rosette	1	10
7	04 23 10 004 03 90	fixing set	1	2
8	90 17 09 051 00 90	diverter	1	2