











META Wall-mounted valve cold water without pop-up waste - Brushed Platinum

META

30 010 662



- 126mm projection
- fixed spout
- circular, air-enriched flow
- hole diameter 35 mm
- rosette Ø 60 mm
- max. flow 4.5 l/min
- lead-free
- This product can help a building meet the requirements of Green Building Rating Systems, e.g. LEED®, BREEAM®, DGNB

	Brushed Platinum	30 010 662-06 0010
	Chrome	30 010 662-00 0010
	Light Gold	30 010 662-26 0010
	Brushed Light Gold	30 010 662-27 0010
	Matte Black	30 010 662-33 0010
	Brushed Bronze	30 010 662-42 0010
	Brushed Champagne (22kt Gold)	30 010 662-46 0010
	Champagne (22kt Gold)	30 010 662-47 0010
	Brushed Chrome	30 010 662-93 0010
	Brushed Dark Platinum	30 010 662-99 0010

Recommended miscellaneous

	Concealed wall elbow - <ul style="list-style-type: none"> • max. recess depth 163 mm • min. recess depth 90 mm 	35 085 970-90 0010
---	--	-----------------------



META Wall-mounted valve cold water without pop-up waste - Brushed Platinum

META

30 010 662

mm [inches]

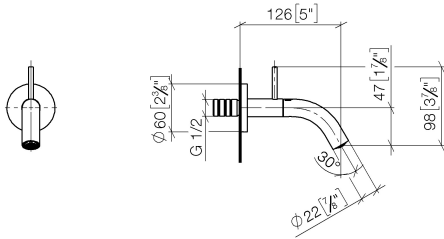

Flow rate chart

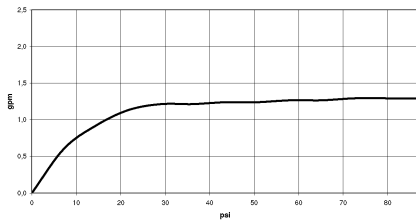

Codes & Standards

ASME A112.18.1	California Energy Commission (CEC)	cUPC	EPA WaterSense
NSF372	NSF61	Water Sense	WaterSense 



META Wall-mounted valve cold water without pop-up waste - Brushed Platinum

META

30 010 662

Certificates

IAPMO_4976

IAPMO_8834

IAPMO_N-4

IAPMO_6

30 010 662

Product version from 5/1/2022

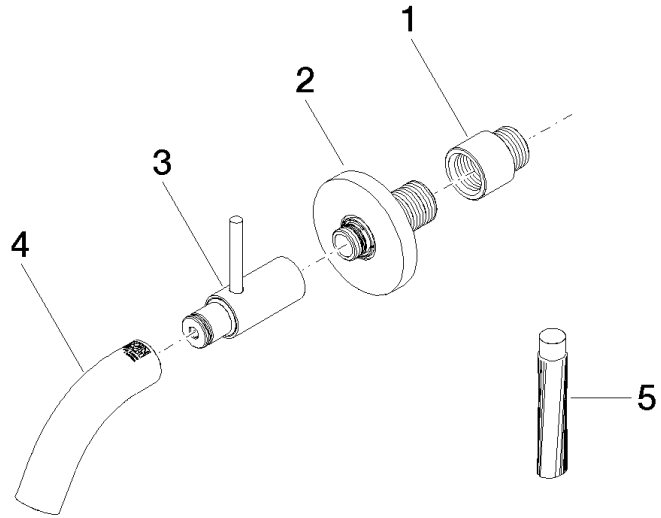



META Wall-mounted valve cold water without pop-up waste - Brushed Platinum

META

30 010 662

Spare parts list

Product version from 5/1/2022

No.	Item Number	Name	Quantity used	Delivery time
	09 24 03 072 10 90	nipple	5	2