











**META Wall-mounted valve cold water without pop-up waste - Brushed  
Champagne (22kt Gold)**

META

30 010 662



- 126mm projection
- fixed spout
- circular, air-enriched flow
- hole diameter 35 mm
- rosette Ø 60 mm
- max. flow 4.5 l/min
- lead-free
- This product can help a building meet the requirements of Green Building Rating Systems, e.g. LEED®, BREEAM®, DGNB

	Brushed Champagne (22kt Gold)	30 010 662-46 0010
	Chrome	30 010 662-00 0010
	Brushed Platinum	30 010 662-06 0010
	Light Gold	30 010 662-26 0010
	Brushed Light Gold	30 010 662-27 0010
	Matte Black	30 010 662-33 0010
	Brushed Bronze	30 010 662-42 0010
	Champagne (22kt Gold)	30 010 662-47 0010
	Brushed Chrome	30 010 662-93 0010
	Brushed Dark Platinum	30 010 662-99 0010



# META Wall-mounted valve cold water without pop-up waste - Brushed Champagne (22kt Gold)

META

30 010 662  
mm [inches]

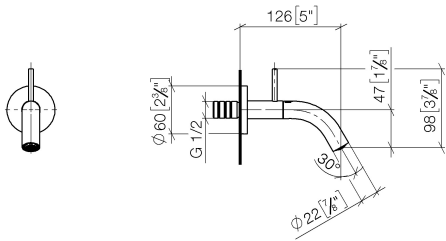

## Flow rate chart

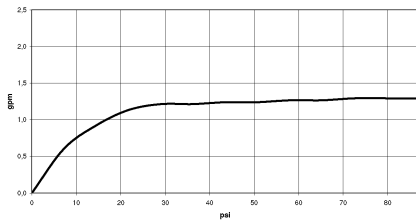

## Codes & Standards

California Energy  
Commission  
(CEC)

NSF372

NSF61



**META Wall-mounted valve cold water without pop-up waste - Brushed  
Champagne (22kt Gold)**

---

META

30 010 662

Certificates

---

IAPMO\_N-4

IAPMO\_6

30 010 662

**Product version from 5/1/2022**

Parts for other  
finishes can be found  
here: [Chrome](#)

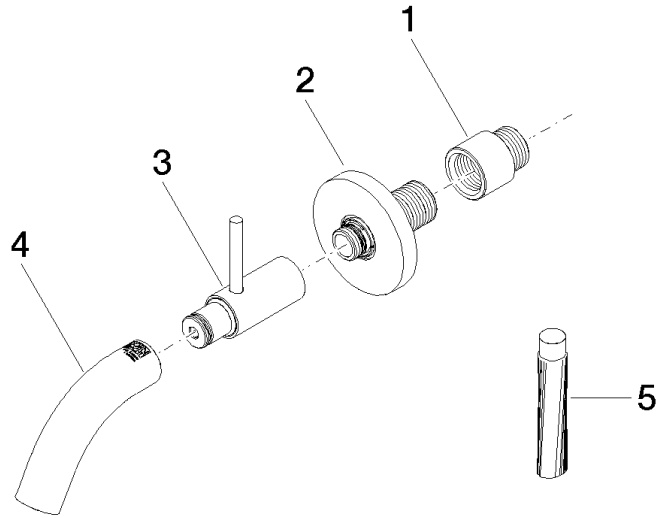



**META Wall-mounted valve cold water without pop-up waste - Brushed  
Champagne (22kt Gold)**

META

30 010 662

**Spare parts list**

**Product version from 5/1/2022**

No.	Item Number	Name	Quantity used	Delivery time
	09 24 03 072 10 90	nipple	5	2