

**META Single-lever basin mixer with pop-up waste - Brushed Champagne (22kt Gold)**











META

33 501 660



- 125mm projection
- 1 1/4" pop-up waste
- fixed spout
- circular, air-enriched flow
- height of mixer 133 mm
- height up to aerator 52 mm
- hole diameter 35 mm
- 2x screw-in M 8 x 1 pressure hose, leak-tested
- 2 x pressure hose with 3/8" cap nut
- max. flow 4.5 l/min
- lead-free
- This product can help a building meet the requirements of Green Building Rating Systems, e.g. LEED®, BREEAM®, DGNB

Only suitable for basins with an overflow.

	Brushed Champagne (22kt Gold)	33 501 660-46 0010
	Chrome	33 501 660-00 0010
	Brushed Platinum	33 501 660-06 0010
	Dark Chrome	33 501 660-19 0010
	Light Gold	33 501 660-26 0010
	Brushed Light Gold	33 501 660-27 0010
	Matte Black	33 501 660-33 0010
	Brushed Bronze	33 501 660-42 0010
	Champagne (22kt Gold)	33 501 660-47 0010
	Brushed Chrome	33 501 660-93 0010
	Brushed Dark Platinum	33 501 660-99 0010



**META Single-lever basin mixer with pop-up waste - Brushed Champagne (22kt Gold)**

META

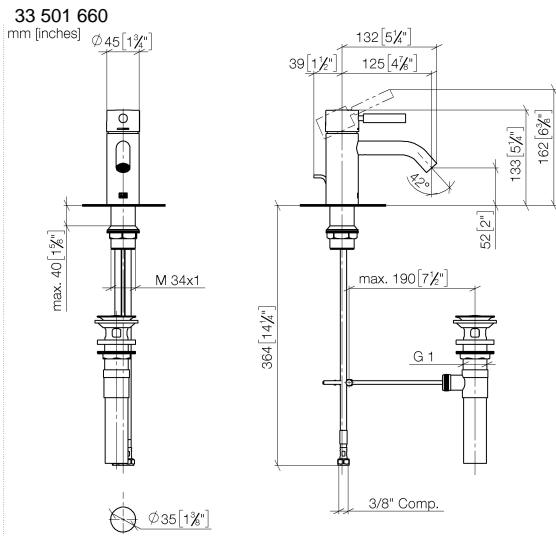

**Flow rate chart**

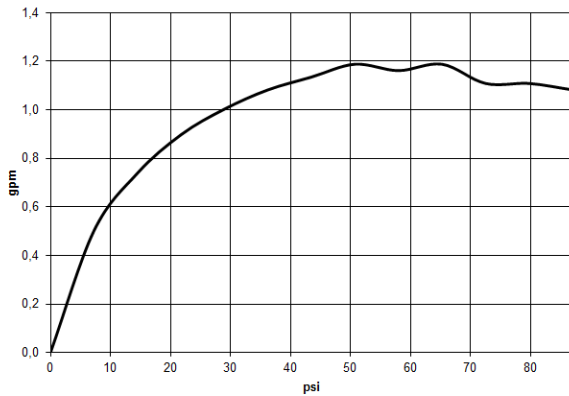

**Codes & Standards**

ADA

ASME  
A112.18.1/CSA  
B125.1

California Energy  
Commission  
(CEC)

NSF/ANSI 372

NSF/ANSI/CAN  
61



META Single-lever basin mixer with pop-up waste - Brushed Champagne (22kt Gold)

---

META

33 501 660

Certificates

---

IAPMO\_N-4976 (1). IAPMO\_6397 (1).

META Single-lever basin mixer with pop-up waste - Brushed Champagne (22kt Gold)

META

33 501 660

Parts for other  
finishes can be found  
here: [Chrome](#)

