

META META SLIM Single-lever basin mixer with pop-up waste - Brushed Platinum















META

33 501 662



- 125mm projection
- 1 1/4" pop-up waste
- fixed spout
- circular, air-enriched flow
- height of mixer 134 mm
- height up to aerator 52 mm
- hole diameter 35 mm
- 2 x pressure hose with 3/8" cap nut
- max. flow 4.5 l/min
- lead-free
- This product can help a building meet the requirements of Green Building Rating Systems, e.g. LEED®, BREEAM®, DGNB

Only suitable for basins with an overflow.

	Brushed Platinum	33 501 662-06 0010
	Chrome	33 501 662-00 0010
	Platinum	33 501 662-08 0010
	Dark Chrome	33 501 662-19 0010
	Light Gold	33 501 662-26 0010
	Brushed Light Gold	33 501 662-27 0010
	Brushed Durabrass (23kt Gold)	33 501 662-28 0010
	Red	33 501 662-29 0010
	Orange	33 501 662-30 0010
	Dark Green	33 501 662-31 0010
	Matte Black	33 501 662-33 0010
	Brushed Bronze	33 501 662-42 0010
	Brushed Champagne (22kt Gold)	33 501 662-46 0010
	Champagne (22kt Gold)	33 501 662-47 0010
	Brushed Chrome	33 501 662-93 0010
	Brushed Dark Platinum	33 501 662-99 0010



META META SLIM Single-lever basin mixer with pop-up waste - Brushed Platinum

META

33 501 662
mm [inches]

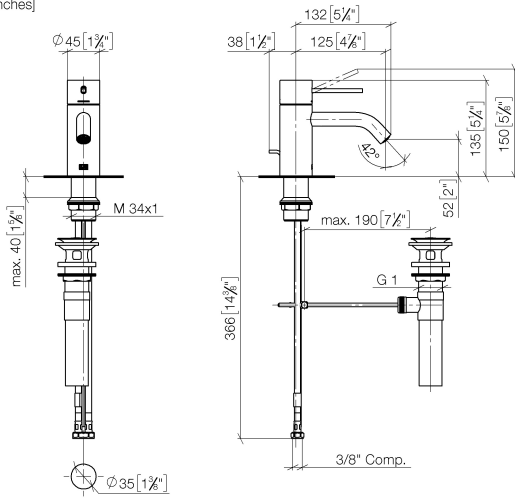

Flow rate chart



Codes & Standards

ADA

ASME
A112.18.1/CSA
B125.1

California Energy
Commission
(CEC)

NSF/ANSI 372

NSF/ANSI/CAN
61

Water Sense





META META SLIM Single-lever basin mixer with pop-up waste - Brushed
Platinum

META

33 501 662

Certificates

IAPMO_4976 (5). IAPMO_8834 (2). IAPMO_N-4976 (1). IAPMO_6397 (1).

33 501 662
Parts for other
finishes can be found
here: [Chrome](#)

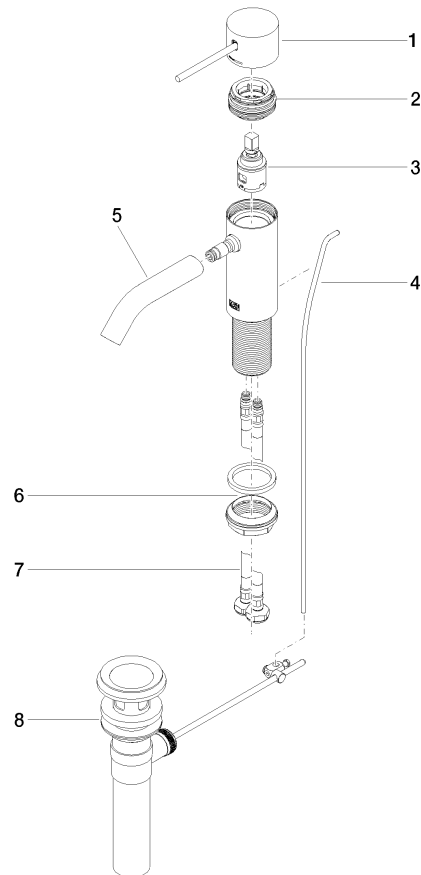

Spare parts list

No.	Item Number	Name	Quantity used	Delivery time
1	90 20 66 020 00-06	handle	1	10
2	90 24 04 536 00 90	threaded connector	1	60
3	90 15 05 042 00 90	cartridge	1	2
4	09 31 09 110-06	pull-rod	1	10
5	90 11 06 206 01-06	spout	1	10
6	04 23 10 044 07 90	fixing set	1	2
7	04 30 04 102 00 90	High pressure hose 3/8" -	2	2
8	90 11 01 023 00-06	pop-up waste	1	10