

META Single-lever basin mixer with pop-up waste - Brushed Champagne (22kt Gold)











META

33 502 660



- 135mm projection
- 1 1/4" pop-up waste
- fixed spout
- circular, air-enriched flow
- height of mixer 158 mm
- height up to aerator 77 mm
- hole diameter 35 mm
- 2 x pressure hose with 3/8" cap nut
- max. flow 4.5 l/min
- lead-free
- This product can help a building meet the requirements of Green Building Rating Systems, e.g. LEED®, BREEAM®, DGNB

Only suitable for basins with an overflow.

	Brushed Champagne (22kt Gold)	33 502 660-46 0010
	Chrome	33 502 660-00 0010
	Brushed Platinum	33 502 660-06 0010
	Dark Chrome	33 502 660-19 0010
	Light Gold	33 502 660-26 0010
	Brushed Light Gold	33 502 660-27 0010
	Matte Black	33 502 660-33 0010
	Brushed Bronze	33 502 660-42 0010
	Champagne (22kt Gold)	33 502 660-47 0010
	Brushed Chrome	33 502 660-93 0010
	Brushed Dark Platinum	33 502 660-99 0010



META Single-lever basin mixer with pop-up waste - Brushed Champagne (22kt Gold)

META

33 502 660

Certificates

IAPMO_N-4976 (1). IAPMO_6397 (1).

33 502 660
Parts for other
finishes can be found
here: [Chrome](#)

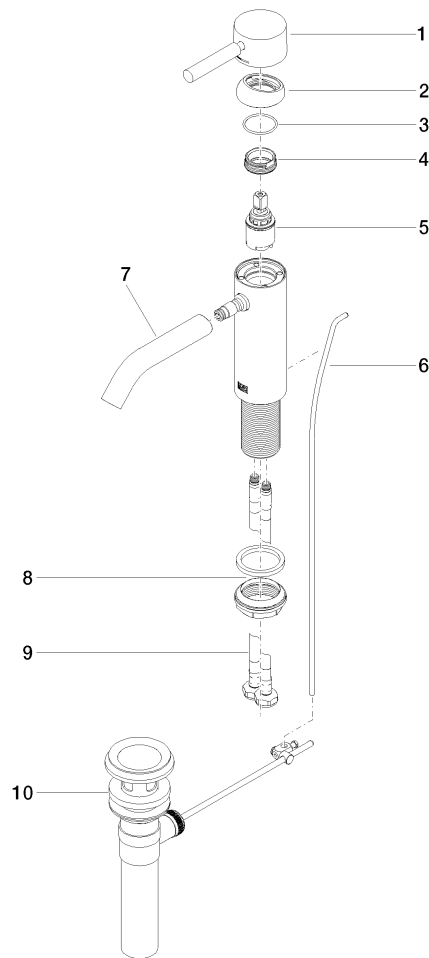

Spare parts list

No.	Item Number	Name	Quantity used	Delivery time
1	90 20 66 002 00-46	handle	1	30
2	09 28 30 041-46	cover	1	30
3	09 14 10 091 90	seal	1	2
4	09 24 04 266 90	nut	1	2
5	90 15 05 044 00 90	cartridge	1	2
6	09 31 09 110-46	pull-rod	1	60
7	90 11 06 207 01-46	spout	1	30
8	04 23 10 044 07 90	fixing set	1	2
9	04 30 04 102 00 90	High pressure hose 3/8" -	2	2
10	90 11 01 023 00-46	pop-up waste	1	30