





33 505 811



- 177mm projection
- 1 1/4" pop-up waste
- fixed spout
- rectangular, air-enriched flow
- height of mixer 198 mm
- height up to aerator 133 mm
- hole diameter 35 mm
- max. flow 4.5 l/min
- 2 x pressure hose with 3/8" cap nut
- lead-free
- This product can help a building meet the requirements of Green Building Rating Systems, e.g. LEED®, BREEAM®, DGNB

Only suitable for basins with an overflow.

Distance from centre of tap hole to wall min. 55 mm
or to front edge of basin min. 40 mm.

	Dark Chrome	33 505 811-19 0010
	Chrome	33 505 811-00 0010
	Brushed Platinum	33 505 811-06 0010
	Brushed Durabronze (23kt Gold)	33 505 811-28 0010
	Brushed Dark Platinum	33 505 811-99 0010

33 505 811

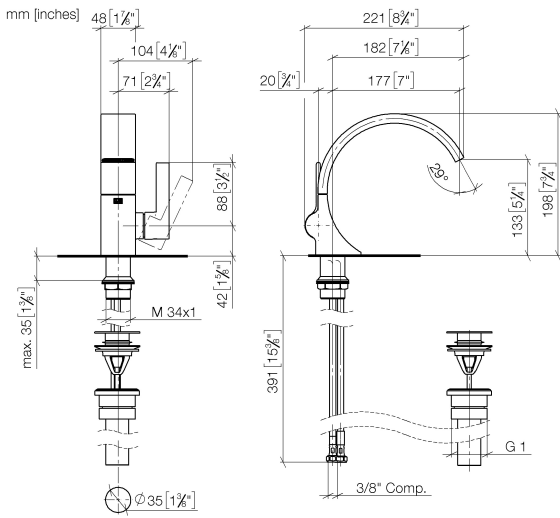

Flow rate chart

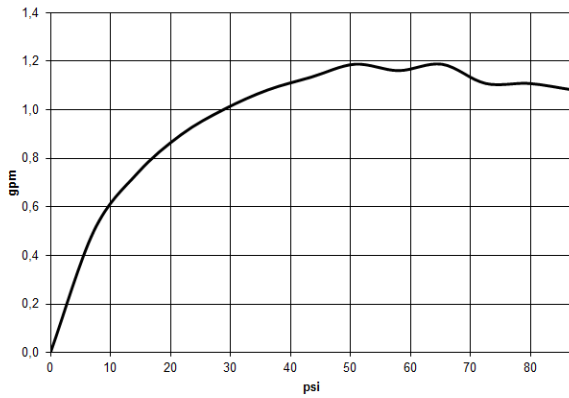

Codes & Standards

California Energy
Commission
(CEC)



CYO Single-lever basin mixer with pop-up waste - Dark Chrome

CYO

33 505 811

Certificates

IAPMO_N-4976 (1). IAPMO_6397 (1).

33 505 811

Parts for other finishes can be found here: [Chrome](#)

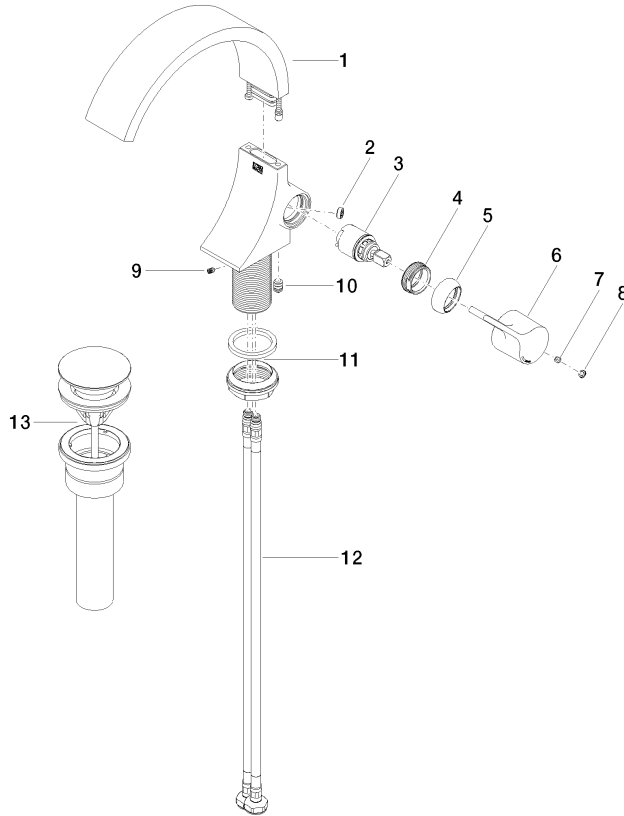

Spare parts list

No.	Item Number	Name	Quantity used	Delivery time
1	90 11 70 013 01-19	spout	1	20
2	09 23 01 172 90	flow reducer	1	2
3	90 15 05 044 00 90	cartridge	1	2
4	09 24 04 266 90	nut	1	2
5	09 28 30 021-19	cover	1	20
6	09 20 80 024-19	handle	1	20
7	90 31 11 030 00 90	pin	1	2
8	90 31 20 087 00-19	plug	1	20
9	09 31 11 008 90	pin	1	2
10	90 31 20 129 00 90	plug	1	2
11	04 23 10 044 07 90	fixing set	1	2
12	04 30 04 102 00 90	High pressure hose 3/8" -	2	2
13	10 125 970-19 0010	Basin Waste 1 1/4" - Dark Chrome	1	20