

LISSÉ Single-lever basin mixer with raised base with pop-up waste - Brushed Platinum







LISSÉ

33 506 845



- 130mm projection
- 1 1/4" pop-up waste
- fixed spout
- circular, air-enriched flow
- height of mixer 236 mm
- height up to aerator 185 mm
- hole diameter 35 mm
- 2 x pressure hose with 3/8" cap nut
- max. flow 4.5 l/min
- lead-free
- This product can help a building meet the requirements of Green Building Rating Systems, e.g. LEED®, BREEAM®, DGNB

Only suitable for basins with an overflow.

	Brushed Platinum	33 506 845-06 0010
	Chrome	33 506 845-00 0010
	Dark Chrome	33 506 845-19 0010
	Matte Black	33 506 845-33 0010
	Brushed Chrome	33 506 845-93 0010
	Brushed Dark Platinum	33 506 845-99 0010



LISSÉ Single-lever basin mixer with raised base with pop-up waste - Brushed
Platinum

LISSÉ

33 506 845

Certificates

IAPMO_8834 (2). IAPMO_N-4976 (1). IAPMO_4976 (3). IAPMO_6397 (1).

33 506 845
Parts for other
finishes can be found
here: [Chrome](#)

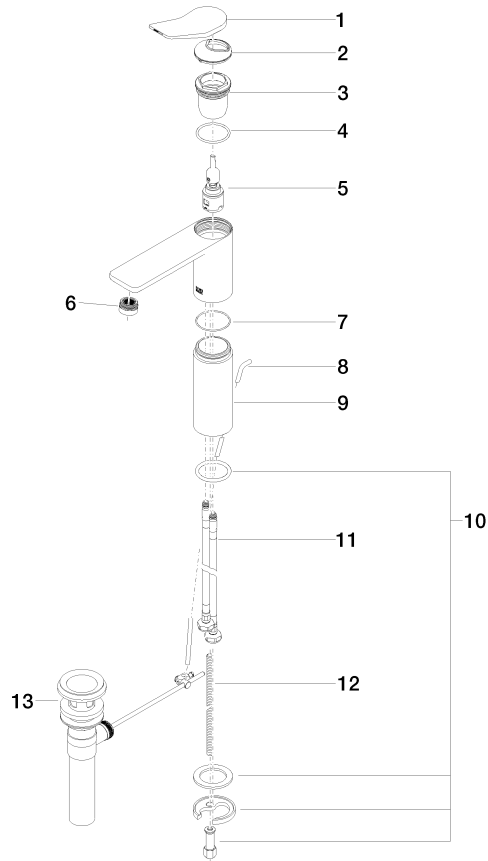

Spare parts list

No.	Item Number	Name	Quantity used	Delivery time
1	90 20 84 020 00-06	handle	1	10
2	09 28 30 034 90	cover	1	2
3	09 23 10 123 90	nut	1	2
4	09 14 10 038 90	seal	1	2
5	90 15 05 042 01 90	cartridge	1	2
6	90 23 01 161 03-06	aerator	1	10
7	09 14 10 108 90	seal	1	2
8	09 31 09 120-06	pull-rod	1	10
9	09 28 22 305-06	sleeve	1	10
10	04 30 11 038 75 90	fixing set	1	2
11	04 30 04 103 00 90	hose	2	2
12	09 31 11 000 90	pin	1	2
13	90 11 01 023 00-06	pop-up waste	1	10