













33 525 660



- 105mm projection
- fixed spout
- circular, air-enriched flow
- height of mixer 138 mm
- height up to aerator 57 mm
- hole diameter 35 mm
- rosette Ø 50 mm optional
- 2 x pressure hose with 3/8" cap nut
- max. flow 4.5 l/min
- lead-free
- This product can help a building meet the requirements of Green Building Rating Systems, e.g. LEED®, BREEAM®, DGNB

	Chrome	33 525 660-00 0010
	Brushed Platinum	33 525 660-06 0010
	Platinum	33 525 660-08 0010
	Dark Chrome	33 525 660-19 0010
	Light Gold	33 525 660-26 0010
	Brushed Light Gold	33 525 660-27 0010
	Brushed Durabronze (23kt Gold)	33 525 660-28 0010
	Red	33 525 660-29 0010
	Orange	33 525 660-30 0010
	Dark Green	33 525 660-31 0010
	Matte Black	33 525 660-33 0010
	Brushed Bronze	33 525 660-42 0010
	Brushed Champagne (22kt Gold)	33 525 660-46 0010
	Champagne (22kt Gold)	33 525 660-47 0010
	Brushed Chrome	33 525 660-93 0010
	Brushed Dark Platinum	33 525 660-99 0010



META Single-lever basin mixer without pop-up waste - Chrome

META

33 525 660

mm [inches]

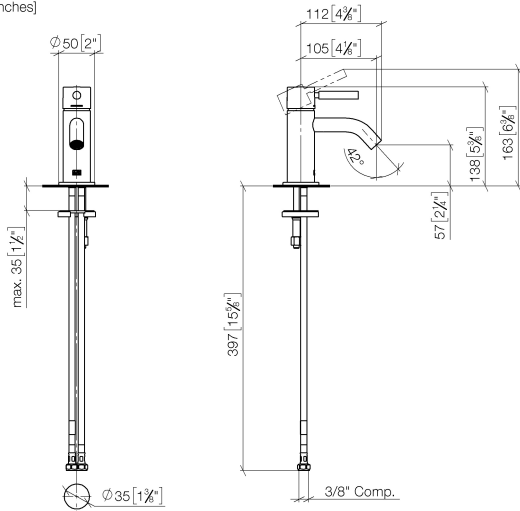

Flow rate chart

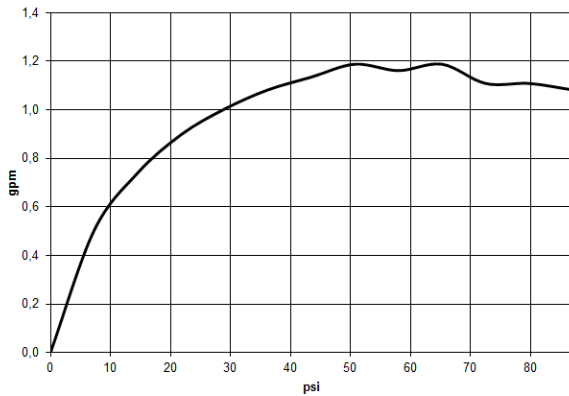

Codes & Standards

ADA

ASME
A112.18.1/CSA
B125.1

California Energy
Commission
(CEC)

NSF/ANSI 372

NSF/ANSI/CAN
61

Water Sense





META Single-lever basin mixer without pop-up waste - Chrome

META

33 525 660

Certificates

IAPMO_8834 (2). IAPMO_4976 (6). IAPMO_N-4976 (1). IAPMO_6397 (1).

33 525 660

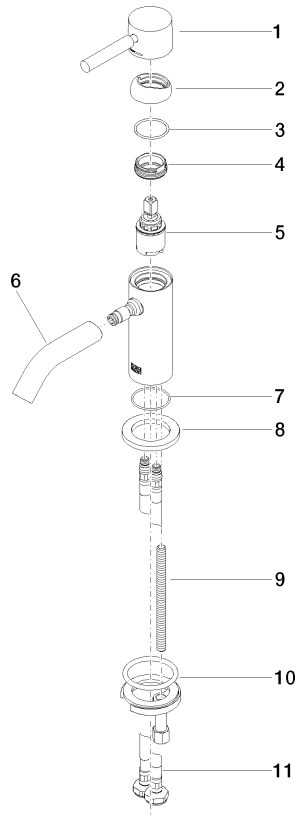

Spare parts list

No.	Item Number	Name	Quantity used	Delivery time
1	90 20 66 009 00-00	handle	1	10
2	09 28 30 043-00	cover	1	10
3	09 14 10 120 90	seal	1	2
4	09 24 04 266 90	nut	1	2
5	90 15 05 044 00 90	cartridge	1	2
6	90 11 06 212 01-00	spout	1	10
7	09 14 10 202 90	seal	1	2
8	09 27 66 006-00	rosette	1	10
9	09 31 11 012 90	pin	1	2
10	04 30 11 038 00 90	fixing set	1	2
11	04 30 04 102 00 90	High pressure hose 3/8" -	2	2