











**META Single-lever basin mixer without pop-up waste - Brushed Champagne (22kt Gold)**

META

33 526 660



- 125mm projection
- fixed spout
- circular, air-enriched flow
- height of mixer 133 mm
- height up to aerator 52 mm
- hole diameter 35 mm
- 2 x pressure hose with 3/8" cap nut
- max. flow 4.5 l/min
- lead-free
- This product can help a building meet the requirements of Green Building Rating Systems, e.g. LEED®, BREEAM®, DGNB

	Brushed Champagne (22kt Gold)	33 526 660-46 0010
	Chrome	33 526 660-00 0010
	Brushed Platinum	33 526 660-06 0010
	Dark Chrome	33 526 660-19 0010
	Light Gold	33 526 660-26 0010
	Brushed Light Gold	33 526 660-27 0010
	Matte Black	33 526 660-33 0010
	Brushed Bronze	33 526 660-42 0010
	Champagne (22kt Gold)	33 526 660-47 0010
	Brushed Chrome	33 526 660-93 0010
	Brushed Dark Platinum	33 526 660-99 0010



# META Single-lever basin mixer without pop-up waste - Brushed Champagne (22kt Gold)

META

33 526 660  
mm [inches]

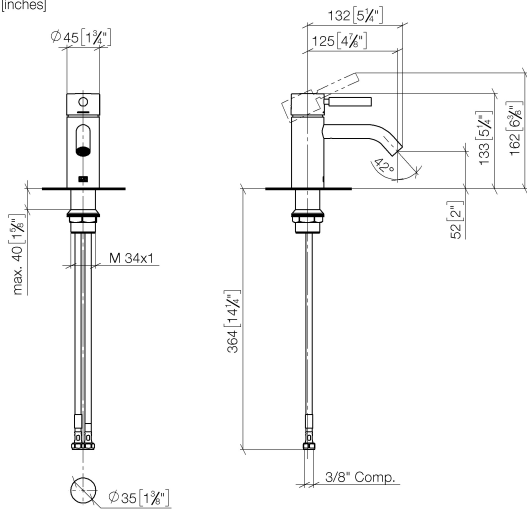

## Flow rate chart

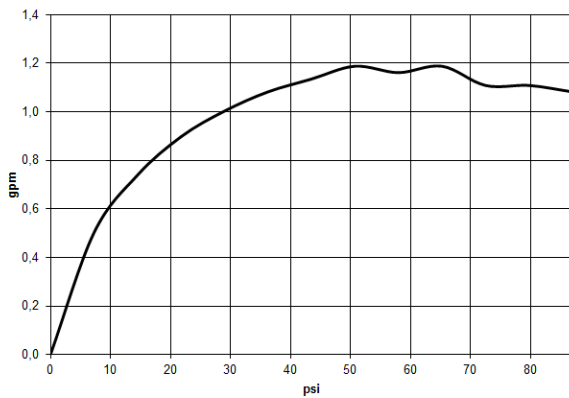

## Codes & Standards

ADA

ASME  
A112.18.1/CSA  
B125.1

California Energy  
Commission  
(CEC)

NSF/ANSI 372

NSF/ANSI/CAN  
61



**META Single-lever basin mixer without pop-up waste - Brushed Champagne  
(22kt Gold)**

---

META

33 526 660

Certificates

---

IAPMO\_N-4976 (1). IAPMO\_6397 (1).

33 526 660  
Parts for other  
finishes can be found  
here: [Chrome](#)

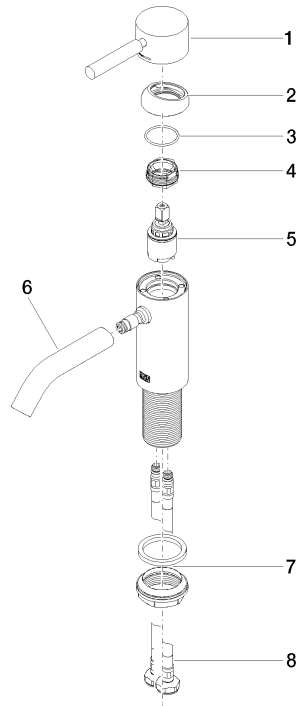

### Spare parts list

No.	Item Number	Name	Quantity used	Delivery time
1	90 20 66 002 00-46	handle	1	30
2	09 28 30 041-46	cover	1	30
3	09 14 10 091 90	seal	1	2
4	09 24 04 266 90	nut	1	2
5	90 15 05 044 00 90	cartridge	1	2
6	90 11 06 206 01-46	spout	1	30
7	04 23 10 044 07 90	fixing set	1	2
8	04 30 04 102 00 90	High pressure hose 3/8" -	2	2