







33 526 660



- 125mm projection
- fixed spout
- circular, air-enriched flow
- height of mixer 133 mm
- height up to aerator 52 mm
- hole diameter 35 mm
- 2 x pressure hose with 3/8" cap nut
- max. flow 4.5 l/min
- lead-free
- This product can help a building meet the requirements of Green Building Rating Systems, e.g. LEED®, BREEAM®, DGNB

	Champagne (22kt Gold)	33 526 660-47 0010
	Chrome	33 526 660-00 0010
	Brushed Platinum	33 526 660-06 0010
	Dark Chrome	33 526 660-19 0010
	Light Gold	33 526 660-26 0010
	Brushed Light Gold	33 526 660-27 0010
	Matte Black	33 526 660-33 0010
	Brushed Bronze	33 526 660-42 0010
	Brushed Champagne (22kt Gold)	33 526 660-46 0010
	Brushed Chrome	33 526 660-93 0010
	Brushed Dark Platinum	33 526 660-99 0010

33 526 660

mm [inches]

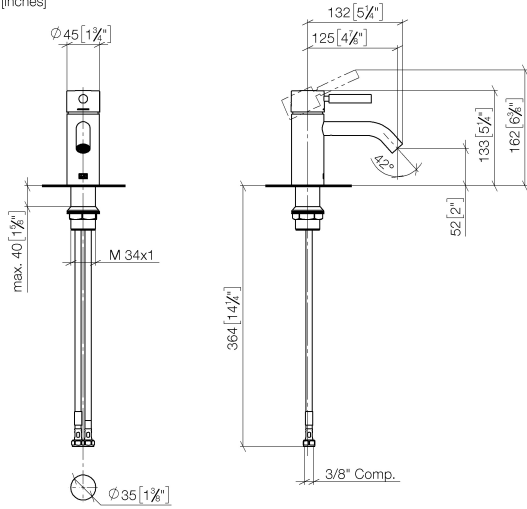

Flow rate chart

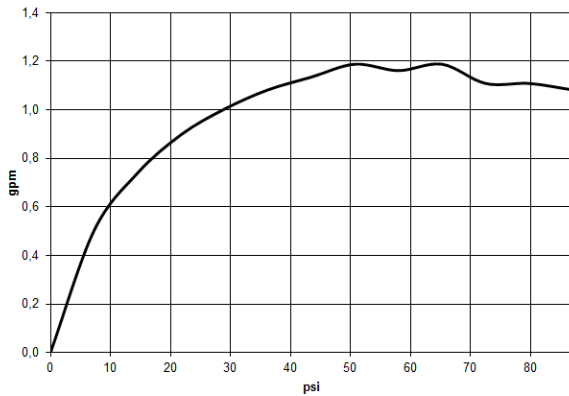

Codes & Standards

ADA

ASME
A112.18.1/CSA
B125.1

California Energy
Commission
(CEC)

NSF/ANSI 372

NSF/ANSI/CAN
61

Water Sense





META Single-lever basin mixer without pop-up waste - Champagne (22kt Gold)

META

33 526 660

Certificates

IAPMO_8834 (1). IAPMO_N-4976 (1). IAPMO_6397 (1).

33 526 660

Parts for other finishes can be found here: [Chrome](#)

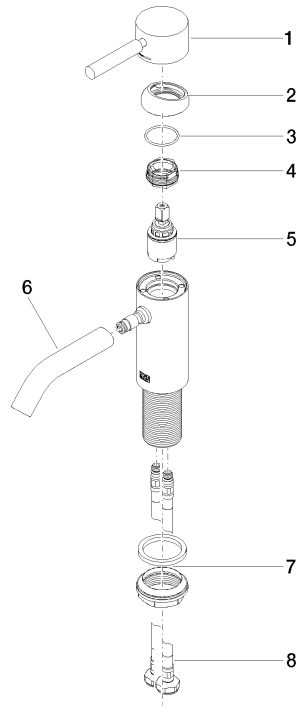

Spare parts list

No.	Item Number	Name	Quantity used	Delivery time
1	90 20 66 002 00-47	handle	1	30
2	09 28 30 041-47	cover	1	60
3	09 14 10 091 90	seal	1	2
4	09 24 04 266 90	nut	1	2
5	90 15 05 044 00 90	cartridge	1	2
6	90 11 06 206 01-47	spout	1	30
7	04 23 10 044 07 90	fixing set	1	2
8	04 30 04 102 00 90	High pressure hose 3/8" -	2	2