

**LISSÉ Single-lever basin mixer with raised base without pop-up waste -
Chrome**







LISSÉ

33 537 845



- 215mm projection
- fixed spout
- circular, air-enriched flow
- height of mixer 292 mm
- height up to aerator 241 mm
- hole diameter 35 mm
- 2 x pressure hose with 3/8" cap nut
- max. flow 4.5 l/min
- lead-free
- This product can help a building meet the requirements of Green Building Rating Systems, e.g. LEED®, BREEAM®, DGNB

for use on countertop bowls

	Chrome	33 537 845-00 0010
	Brushed Platinum	33 537 845-06 0010
	Dark Chrome	33 537 845-19 0010
	Matte Black	33 537 845-33 0010
	Brushed Chrome	33 537 845-93 0010
	Brushed Dark Platinum	33 537 845-99 0010



LISSÉ Single-lever basin mixer with raised base without pop-up waste - Chrome

LISSÉ

33 537 845
mm [inches]

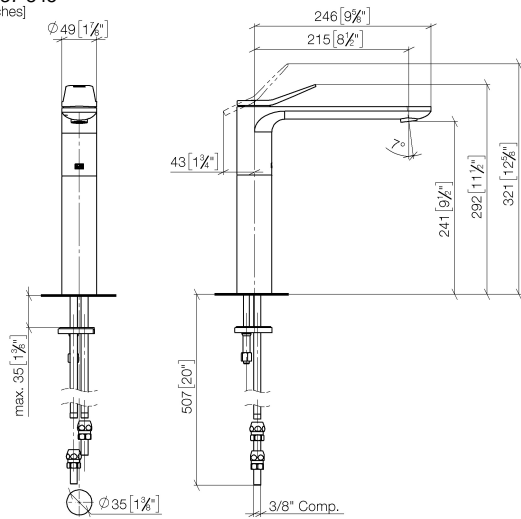

Flow rate chart

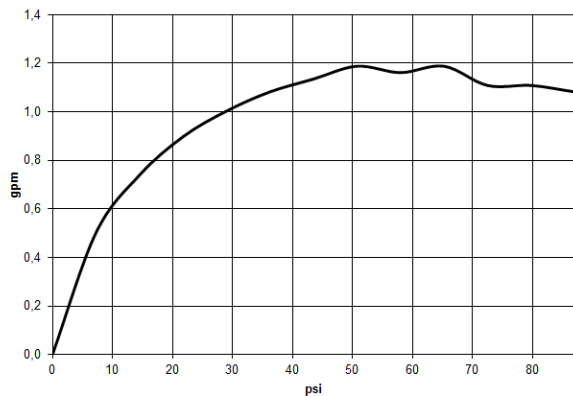

Codes & Standards

ADA

ASME
A112.18.1/CSA
B125.1

California Energy
Commission
(CEC)

NSF/ANSI 372

NSF/ANSI/CAN
61

Water Sense





LISSÉ Single-lever basin mixer with raised base without pop-up waste -
Chrome

LISSÉ

33 537 845

Certificates

IAPMO_8834 (2). IAPMO_N-4976 (1). IAPMO_4976 (3). IAPMO_6397 (1).

33 537 845

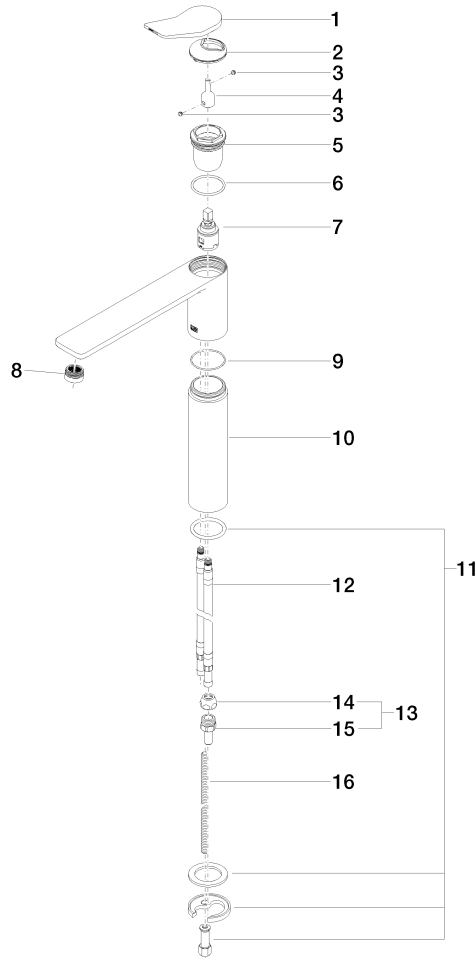

Spare parts list

No.	Item Number	Name	Quantity used	Delivery time
1	90 20 84 020 00-00	handle	1	10
2	09 28 30 034 90	cover	1	2
3	90 31 11 063 00 90	pin	2	2
4	09 29 06 117-07	extension	1	30
5	09 23 10 123 90	nut	1	2
6	09 14 10 038 90	seal	1	2
7	90 15 05 042 00 90	cartridge	1	2
8	90 23 01 161 03-00	aerator	1	10
9	09 14 10 108 90	seal	1	2
10	09 28 22 306-00	sleeve	1	10
11	04 30 11 038 75 90	fixing set	1	2
12	04 30 04 098 00 90	hose	2	60
13	04 24 04 222 00-00	adaptor	1	10
14	04 23 30 031 01-07	threaded connector	2	60
15	09 24 04 222 10-00	adaptor	2	10
16	09 31 11 095 90	pin	1	2