











33 805 809



- 167mm projection
- pivotable spout 360°
- air-enriched flow
- height of mixer 306 mm
- height up to laminar flow regulator 224 mm
- hole diameter 35 mm
- 2 x pressure hose with 3/8" cap nut
- max. flow 5.6 l/min at 3 bar flow pressure
- lead-free
- This product can help a building meet the requirements of Green Building Rating Systems, e.g. LEED®, BREEAM®, DGNB

Not possible in combination with rinsing spray.

	Chrome	33 805 809-00 0010
	Brushed Platinum	33 805 809-06 0010
	Platinum	33 805 809-08 0010
	Durabrand (23kt Gold)	33 805 809-09 0010
	Dark Chrome	33 805 809-19 0010
	Brushed Durabrand (23kt Gold)	33 805 809-28 0010
	Matte Black	33 805 809-33 0010
	Brushed Champagne (22kt Gold)	33 805 809-46 0010
	Champagne (22kt Gold)	33 805 809-47 0010
	Brushed Chrome	33 805 809-93 0010
	Brushed Dark Platinum	33 805 809-99 0010

Recommended miscellaneous

VAIA Dispenser with rosette - Chrome 82 434 809-00



Recommended miscellaneous

VAIA AIR SWITCH Control button - Chrome 10 713 809-00



33 805 809

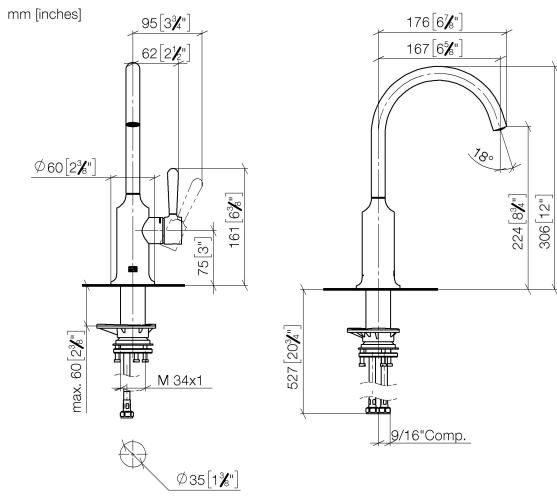

Flow rate chart

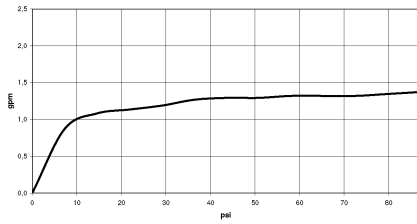

Codes & Standards

California Energy
Commission
(CEC)

33 805 809

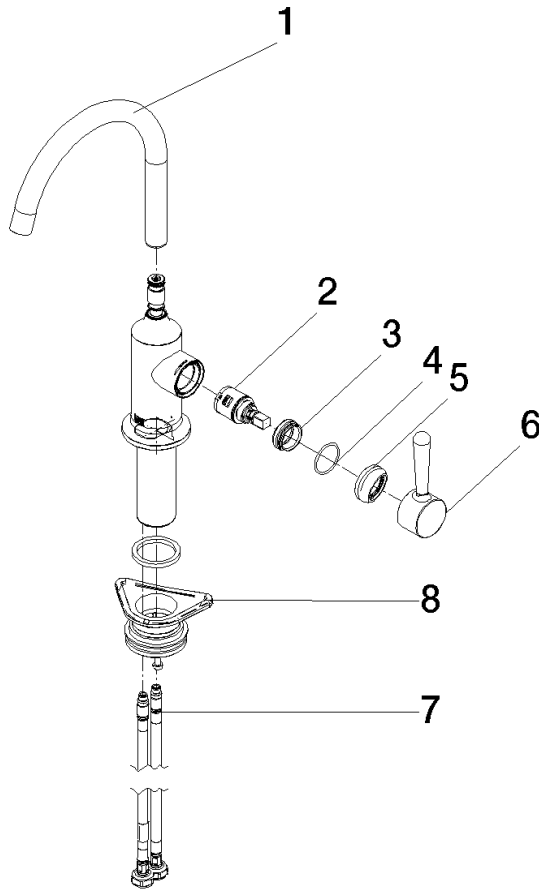

Spare parts list

No.	Item Number	Name	Quantity used	Delivery time
1	90 28 22 311 00-00	spout	1	10
2	90 15 05 042 00 90	cartridge	1	2
3	09 24 04 266 90	nut	1	2
4	09 14 10 091 90	seal	1	2
5	90 28 30 052 00-00	cover	1	10
6	90 20 80 050 00-00	handle	1	10
7	04 30 04 103 00 90	hose	2	2
8	04 23 10 044 08 90	fixing set	1	2