





33 805 875



- 166mm projection
- pivotable spout 360°
- laminar flow
- height of mixer 303 mm
- height up to laminar flow regulator 186 mm
- hole diameter 35 mm
- 2 x pressure hose with 3/8" cap nut
- max. flow 5.7 l/min at 3 bar flow pressure
- lead-free
- This product can help a building meet the requirements of Green Building Rating Systems, e.g. LEED®, BREEAM®, DGNB

Not possible in combination with rinsing spray.

	Chrome	33 805 875-00 0010
	Brushed Platinum	33 805 875-06 0010
	Platinum	33 805 875-08 0010
	Durabrace (23kt Gold)	33 805 875-09 0010
	Dark Chrome	33 805 875-19 0010
	Brushed Durabrace (23kt Gold)	33 805 875-28 0010
	Matte Black	33 805 875-33 0010
	Brushed Champagne (22kt Gold)	33 805 875-46 0010
	Champagne (22kt Gold)	33 805 875-47 0010
	Brushed Chrome	33 805 875-93 0010
	Brushed Dark Platinum	33 805 875-99 0010

**Recommended miscellaneous**

**AIR SWITCH Control button - Chrome** 10 713 970-00



**Recommended miscellaneous**

**Dispenser without rosette - Chrome** 82 424 970-00





# TARA ULTRA BAR TAP Single-lever mixer - Chrome

TARA ULTRA

33 805 875

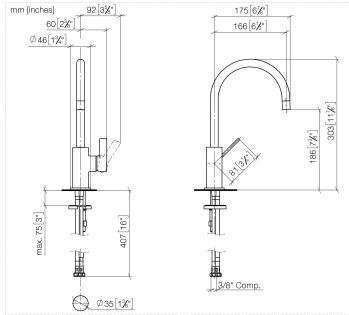

## Flow rate chart

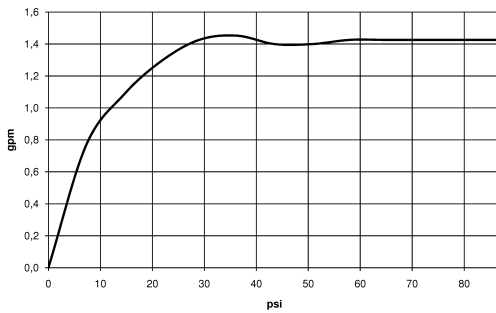

## Codes & Standards

ADA

ASME  
A112.18.1/CSA  
B125.1

California Energy  
Commission  
(CEC)

NSF/ANSI 372

NSF/ANSI/CAN  
61



## TARA ULTRA BAR TAP Single-lever mixer - Chrome

---

TARA ULTRA

33 805 875

### Certificates

---

IAPMO\_6397 (1).

33 805 875

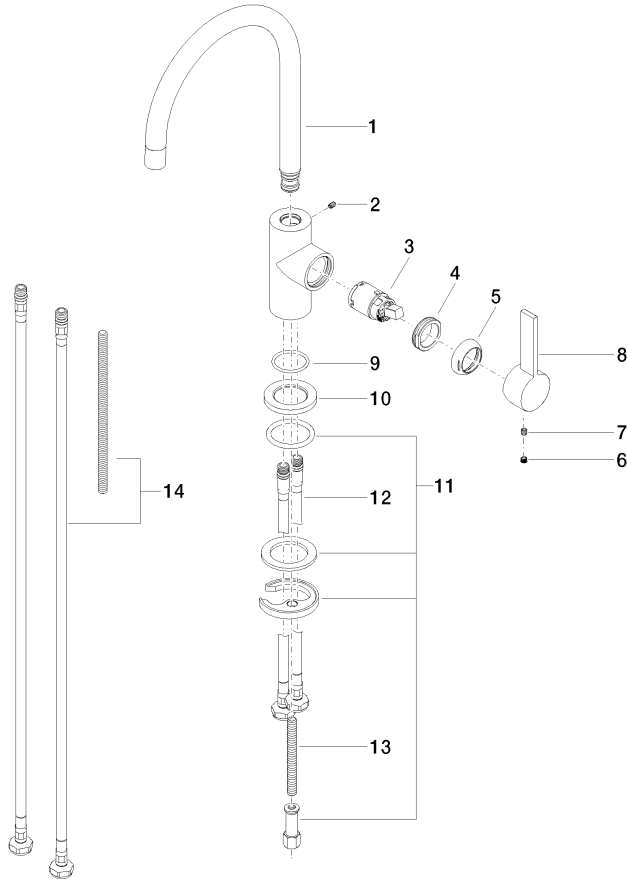

**Spare parts list**

No.	Item Number	Name	Quantity used	Delivery time
1	90 28 22 206 01-00	spout	1	10
2	09 31 11 008 90	pin	1	2
3	90 15 05 041 00 90	cartridge	1	2
4	09 24 04 130-07	nut	1	30
5	09 24 04 204-00	cover	1	10
6	90 31 20 109 00 90	plug	1	2
7	90 31 11 030 00 90	pin	1	2
8	09 20 88 051-00	handle	1	10
9	09 14 10 118 90	seal	1	2
10	09 27 85 001-00	rosette	1	10
11	04 30 11 038 64 90	fixing set	1	2
12	04 30 04 106 00 90	hose	2	2
13	09 31 11 011 90	pin	1	2
14	12 803 970-90 0010	Extension set -	1	60